

**MaxShine®**  
Private Label



IN PURSUIT OF AUTOMOTIVE PERFECTION  
**SINCE 2006**  
NO. 2026/2027

## MAXSHINE HQ

📍 3rd. Floor, 1# Building, No.1 Fuyuan Road Jiujiang EDZ, Wuhu, 241000 China  
☎ +86 553 3932 199 ; +86 553 4996 266  
🌐 [www.maxshinechina.com](http://www.maxshinechina.com)  
✉ [sales@maxshinechina.com](mailto:sales@maxshinechina.com)

# About Maxshine

For over 20 years, Maxshine has been a leading manufacturer specializing in long-throw dual action polishers and premium auto detailing products. Today, our brand is recognized in more than 50 countries and regions worldwide as one of the most trusted names in car care.

Our rapid global growth stems from an unwavering passion and dedication to the art of detailing. Innovation has always been at the core of our development, driving us to integrate the latest technology and deliver products that elevate the detailing experience.

At Maxshine, we are committed to providing high-quality products paired with exceptional customer service. From the moment of purchase to our comprehensive after-sales support, we ensure every customer enjoys a seamless and satisfying experience. Designed with high-grade materials, precision engineering, and a clean, functional style, Maxshine products bring excellence and reliability to every detailer's toolkit.

In recent years, we have expanded our capabilities through strategic partnerships, including joint ventures with suppliers in China to enhance quality control and innovation in categories. These collaborations reflect our commitment to continuous improvement and to offering the most cost-effective, high-performance solutions for professional and enthusiast detailers alike.

Looking ahead, Maxshine will continue to innovate, grow, and set higher standards in the detailing industry. Our promise is simple: we will never stop progressing, never stop improving, and never stop fueling the passion for detailing worldwide.

Maxshine – All For Detailing

*Maxshine  
Team*





- |              |                 |                    |               |                    |
|--------------|-----------------|--------------------|---------------|--------------------|
| 1 AMERICA    | 16 JAPAN        | 31 SWEDEN          | 46 IRAN       | 61 THE PHILIPPINES |
| 2 ARGENTINA  | 17 MEXICO       | 32 SINGAPORE       | 47 LITHUANIA  | 62 GIBRALTAR       |
| 3 AUSTRALIA  | 18 MAURITIUS    | 33 TAIWAN          | 48 KAZAKHSTAN | 63 TRINIDAD        |
| 4 BRAZIL     | 19 MALAYSIA     | 34 THE NETHERLANDS | 49 QATAR      | 64 ALGERIA         |
| 5 BRUNEI     | 20 NORWAY       | 35 TURKEY          | 50 COSTA RICA | 65 PANAMA          |
| 6 BELGIUM    | 21 NEW ZEALAND  | 36 THAILAND        | 51 REUNION    | 66 LEBANON         |
| 7 CANADA     | 22 PAKISTAN     | 37 THE MIDDLE EAST | 52 BOLIVIA    | 67 EGYPT           |
| 8 DENMARK    | 23 POLAND       | 38 UNTIED KINGDOM  | 53 CYPRUS     | 68 UZBEKISTAN      |
| 9 FRANCE     | 24 PORTUGAL     | 39 VIETNAM         | 54 IRAQ       | 69 PARAGUAY        |
| 10 FINLAND   | 25 PERU         | 40 CAMBODIA        | 55 SRI LANKA  | 70 SERBIA          |
| 11 GERMANY   | 26 RUSSIA       | 41 COLOMBIA        | 56 MYANMAR    | 71 UKRAINE         |
| 12 GREECE    | 27 SOUTH KOREA  | 42 PUERTO RICO     | 57 BAHRAIN    | 72 KUWAIT          |
| 13 INDONESIA | 28 SPAIN        | 43 SAUDI ARABIA    | 58 ISRAEL     | 73 KOSOVO          |
| 14 INDIA     | 29 SOUTH AFRICA | 44 CHILE           | 59 SLOVENIA   | .....              |
| 15 ITALY     | 30 SWITZERLAND  | 45 IRELAND         | 60 URUGUAY    |                    |

*One Of The Most Popular Auto Detailing Brands In More Than 100 Countries  
And Regions Around The World*





# CONTENT

- 02 • ABOUT MAXSHINE
- 07 • DUAL ACTION POLISHER
- 21 • ROTARY POLISHER
- 35 • PLATE BACKING PAD
- 39 • PREMIUM MICROFIBER TOWEL

- 59 • PREMIUM MICROFIBER WASH MITT
- 69 • PREMIUM MICROFIBER WASH PAD
- 75 • SHEEPSKIN NATURAL WASH MITT
- 81 • SCRUB NINJA SPONGE
- 85 • FOAM POLISHING PAD
- 93 • PREMIUM MICROFIBER DA PAD

- 97 • WOOL POLISHING PAD
- 109 • DETAILING BRUSH
- 139 • PREMIUM CAR DUSTER
- 147 • CLAY PRODUCTS SERIES
- 155 • SNOW FOAM LANCE
- 167 • TORNADOR CLEANING GUN

- 175 • DETAILING SPRAYER
- 177 • DETAILING TOOL BAG
- 187 • FOAM WAXING APPLICATOR
- 197 • DETAILING ACCESSORIES
- 219 • CAR DRYER
- 225 • MULTI-FUNCTIONAL HOLDER

# DUAL ACTION POLISHER



Dual Action Polishers Help You Make Vehicles Clean And Shining!  
Dual Action Polishers Help You Make Car Detailing  
Safer and Easier!  
Fast, Effective, Safe and Easy-to-Use!  
Swirl-free, Professional Results with No Risk!  
Easily Remove Swirl Marks and Scratches,  
and Improve Paint Gloss!



# 1000W DUAL ACTION POLISHER

## M6 SERIES



**CNC Steel Counterweight**

High-Precision CNC Parts  
Well-balanced for smooth polishing

**Premium Core Intelligent Protection & Care**

**Soft Start:** Prevent polish splash, increase safety and extend the service life of switch, motor and gears.  
**Constant Speed:** Maintain constant speed output however the load changes.

**Better Operation**

Vibration Inhibition Technology  
Easy to control, beginner friendly.

**Air Vents**

Optimized internal ventilation  
Structure for better heat dissipation

**6-level Stepless Speed Setting**

Control with big button 2200-5000 OPM  
To meet various working conditions

**Cooling Passages Design**

Dust devil multi-hole  
backing plate

ITEM NO.: M6 SERIES						
ITEM NO.	Disc Size	Orbit	Rated Voltage	Input	Spindle Thead	No Load Speed
M6-8	125mm,5"	8mm	110-240V AC	1000W/9A	5/16"-24	2500-6500/min
M6-12	125mm,5"	12mm	110-240V AC	1000W/9A	5/16"-24	2200-5000/min
M6-15	125mm,5"	15mm	110-240V AC	1000W/9A	5/16"-24	2200-5000/min
M6-21	150mm,6"	21mm	110-240V AC	1000W/9A	5/16"-24	2200-5000/min

PU Velcro Backing Plate,D Handle,Wrench,Carbon Brush,Manual.



# 550W DUAL ACTION POLISHER

## M3 SERIES



**CNC Steel Counterweight**  
High-Precision CNC Parts  
Well-balanced for smooth polishing



**Trigger Lock**  
Lock the switch so that the machine can keep running



**Air Vents**  
Optimized internal ventilation  
Structure for better heat dissipation



**6-level Stepless Speed Setting**  
Control with big button 2000-5500 OPM  
To meet various working conditions

ITEM NO.: M3-12	
<b>Dice Size:</b> 75mm,3-3.5"	<b>Input:</b> 550W/5A
<b>Orbit Diameter Size:</b> 12mm	<b>Spindle Thread:</b> 5/16"-24
<b>Rated Voltage:</b> 110-240V AC	<b>No Load Speed:</b> 2000-5500/min
PU Velcro Backing Plate,D Handle,Wrench,Carbon Brush,Manual.	

## 1100W DA POLISHER

**ITEM NO. Disc Size Orbit No Load Speed**

<b>FDA8</b>	150mm, 6"	8mm	160 - 480rpm
-------------	-----------	-----	--------------

Input: 1100w Rated Voltage: 110-240V AC

Polishing Backing pad: 150mm

Supplied with a D-Handle, Spare Set of Brushes & Spanner, Manual, Color box.



## 1100W DA POLISHER

**ITEM NO. Disc Size Orbit No Load Speed**

<b>FDA8-V2</b>	25mm, 6"	8mm	160 - 480rpm
----------------	----------	-----	--------------

Input: 1100w Rated Voltage: 110-240V AC

Polishing Backing pad: 125mm

Supplied with a D-Handle, Spare Set of Brushes & Spanner, Manual, Color box.



# FDA8 SERIES





# 8MM ORBIT DUAL ACTION POLISHER

DA 1000



**Zinc Alloy Counterweight**

High Strength Zinc Alloy Counterweight wear-resistant, corrosion-resistant for smooth polishing.

**Ergonomic Design**

**Soft Grip Hood**  
The soft grip hood absorb vibration and enhance control force.

**Soft Support Bar**  
Stable placement, protect the car paint.

**Better Operation**

Vibration Inhibition Technology  
Easy to control, beginner friendly.

**Air Vents**

Optimized internal ventilation  
Structure for better heat dissipation

**6-level Stepless Speed Setting**

Control with dial 2500-6500 OPM  
To meet various working conditions

**Cooling Passages Design**

Dust devil multi-hole  
backing plate

ITEM NO.: DA1000	
Rated Voltage: 110V - 240V AC	Velcro Backing Plate Size: 125mm ( 5")
Orbit Diameter Size: 8mm	Rated Power: 1000W
Frequency: 60Hz / 50Hz	Polishing Pad Size: 125mm ( 5")
Thread Size: 5/16"-24	Variable Speed: 2,500 - 6,500 OPM
Rated Current: 9Amp.	Net Weight: 2.3kgs (4.8Lbs)
Power Cord 4.0 meters EU/US	
Accessory: PU Velcro Backing Plate,D Handle,Wrench,Carbon Brush,Manual	



# BRUSHLESS DUAL ACTION POLISHER

## BL PRO SERIES



**Accelerator Trigger**

Trigger with auto speed adjustment - accelerates with pressing depth.

**Ergonomic Design**

**Soft Grip Hood**  
The soft grip hood absorb vibration and enhance control force.

**Soft Support Bar**  
Stable placement, protect the car paint.

**Better Operation**

Vibration Inhibition Technology  
Easy to control, beginner friendly.

**Air Vents**

Optimized internal ventilation  
Structure for better heat dissipation

**6-level Stepless Speed Setting**

Control with dial 2200-5200 OPM  
To meet various working conditions

**Brushless Motor**

No carbon brushes to replace. Brushless motor reduces maintenance and extends polisher lifespan. saving time and money

ITEM NO.: BL PRO SERIES							
ITEM NO.	Disc Size	Orbit	Rated Voltage	Input	Spindle Thread	No Load Speed	Counterweight
BL8 Pro	125mm,5"	8mm	110-240V AC	1200W	5/16"-24	2200-6500 OPM	Zinc Alloy Counterweight
BL15 Pro	125mm,5"	15mm	110-240V AC	1200W	5/16"-24	2200-5200 OPM	CNC Steel Counterweight
BL21 Pro	150mm,6"	21mm	110-240V AC	1200W	5/16"-24	2200-5200 OPM	CNC Steel Counterweight
20ft/6m 360-degree Swivel Cable US/EU							

# ROTARY POLISHER

Electronic Switch Maintains Constant Speed under Load. Heavy-Duty Motor Provides High Power.  
Setting with 6-Speed Control  
Comfortable Non-Slip Grip D Handle.  
High Impact Housing with Die Cast Aluminum Head.  
Sealed 100% Ball-Bearing Construction Provides Longer Life.  
Warranty: 1 year warranty against defects in materials or workmanship.



# 1200W BRUSHLESS ROTARY POLISHER

## BL1200 PRO



The soft grip hood absorb vibration and enhance control force.



Trigger with auto speed adjustment - accelerates with pressing depth.



Optimized internal ventilation Structure for better heat dissipation

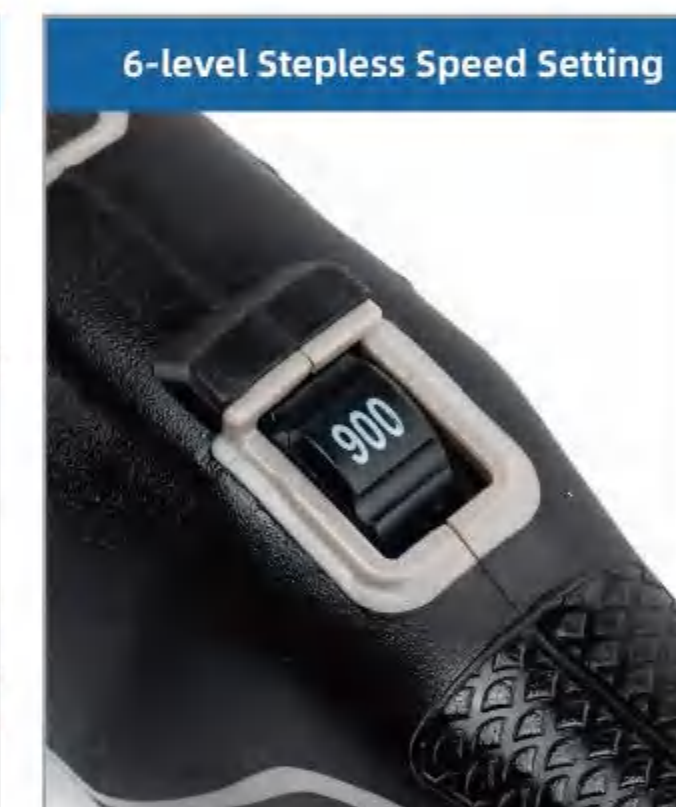

Control with big button 700-3200 RPM To meet various working conditions

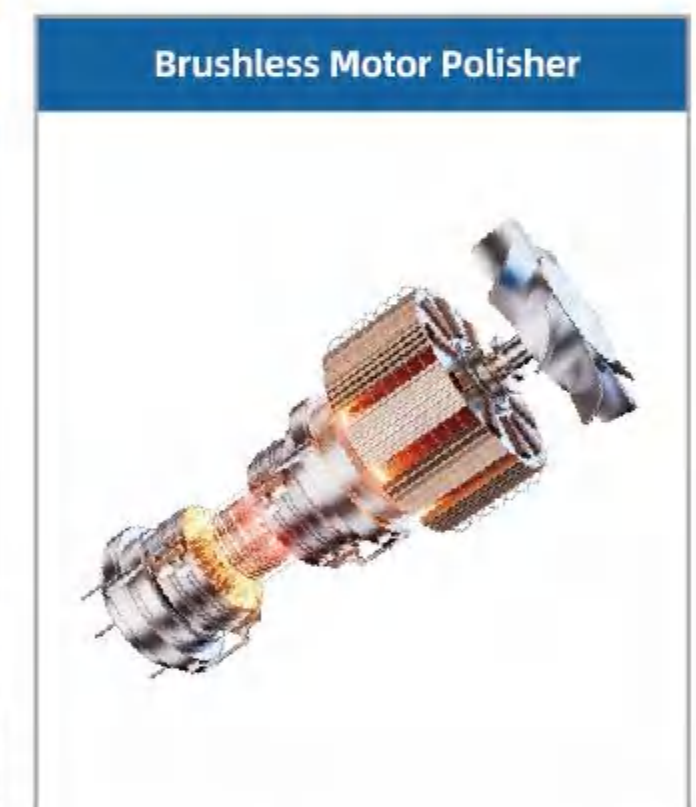

The brushless motor is powerful and has low noise.No spark hazard,don't need replace carbon brushe & rotor to save time and costs.

ITEM NO.: BL1200 Pro	
Rated Voltage: 110-240V AC	Input: 1200W
Spindle Thread: 5/8" or M14	No load speed: 900-3200 RPM
Disc Size: 125mm/5" 150mm/6"	
20ft/6m 360-degree Swivel Cable	



# 550W ROTARY POLISHER

## M3 RP550



**Ergonomic Design**  
Soft Grip Hood  
The soft grip hood absorb vibration and enhance control force.



**Trigger Lock**  
Lock the switch so that the machine can keep running



**Air Vents**  
Optimized internal ventilation  
Structure for better heat dissipation



**6-level Stepless Speed Setting**  
Control with big button 1000-3500 RPM  
To meet various working conditions

### ITEM NO.: M3 RP550

<b>Rated Voltage:</b> 110-240V AC	<b>Input:</b> 550W
<b>Spindle Thread:</b> 5/8" or M14	<b>No load speed:</b> 1000-3500/min
<b>Disc Size:</b> 75mm,3-3.5"	<b>Net Weight:</b> 3.2kgs
Velcro Backing Plate,Side Handle,Wrench,Carbon Brush,Manual.	

1000W



# 1000 WATT ROTARY POLISHER

## M6 RP1000



**Ergonomic Design**  
Soft Grip Hood  
The soft grip hood absorb vibration and enhance control force.



**Premium Core**  
Intelligent Protection & Care  
Soft Start  
Prevent polish splash, increase safety and extend the service life of switch, motor and gears..



**Air Vents**  
Optimized internal ventilation  
Structure for better heat dissipation

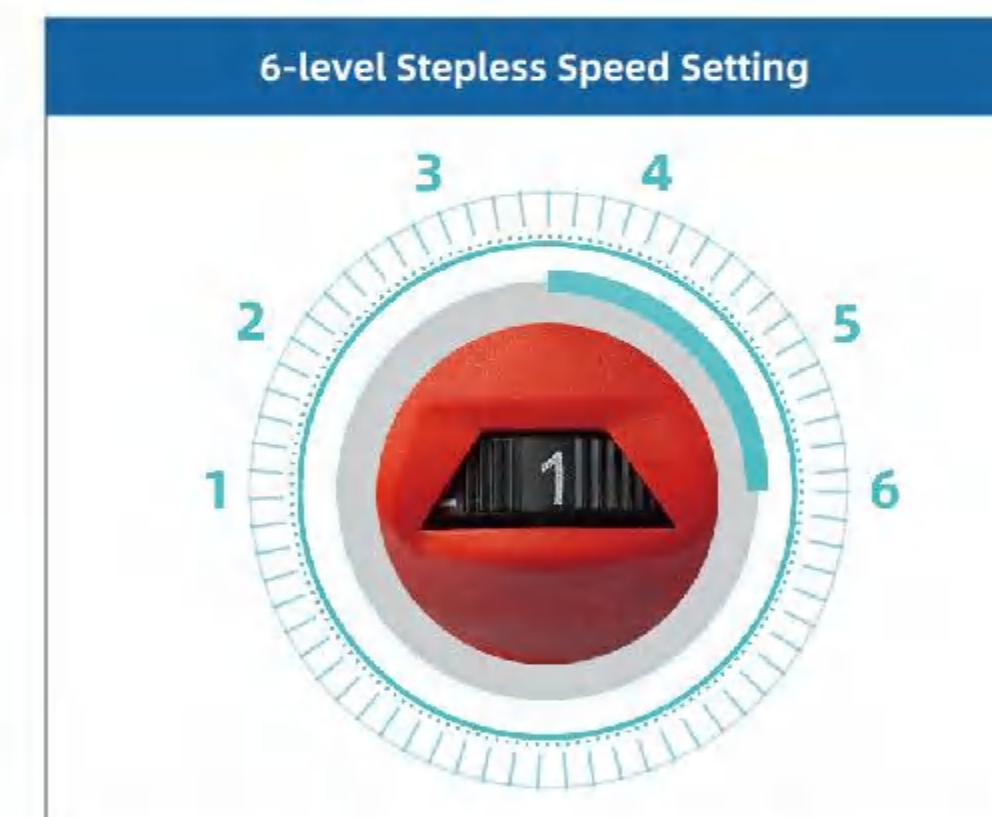

**6-level Stepless Speed Setting**  
Control with big button 800-3300 RPM  
To meet various working conditions

### ITEM NO.: M6 RP1000

Rated Voltage: 110-240V AC

Input: 1000W

Spindle Thread: 5/8" or M14

No load speed: 800-3300/min

Disc Size: 125mm,5"

Net Weight: 3.2kgs

Velcro Backing Plate,Side Handle,Wrench,Carbon Brush,Manual.



# 1300W WATT ROTARY POLISHER

**RP1300**



**Stepless Speed Setting**  
constant power system  
with 6 speed setting

**D-Handle Mount**

**Soft Grip**

**Air Vents**

**Switch With Soft Rubber**

**Ergonomic Design**



**Soft Grip Hood**  
The soft grip hood absorb vibration and enhance control force.

**Premium Core Intelligent Protection & Care**



Soft start with constant Power system  
setting with 6 Speed control

**Air Vents**



Optimized internal ventilation  
Structure for better heat dissipation

**6-level Stepless Speed Setting**

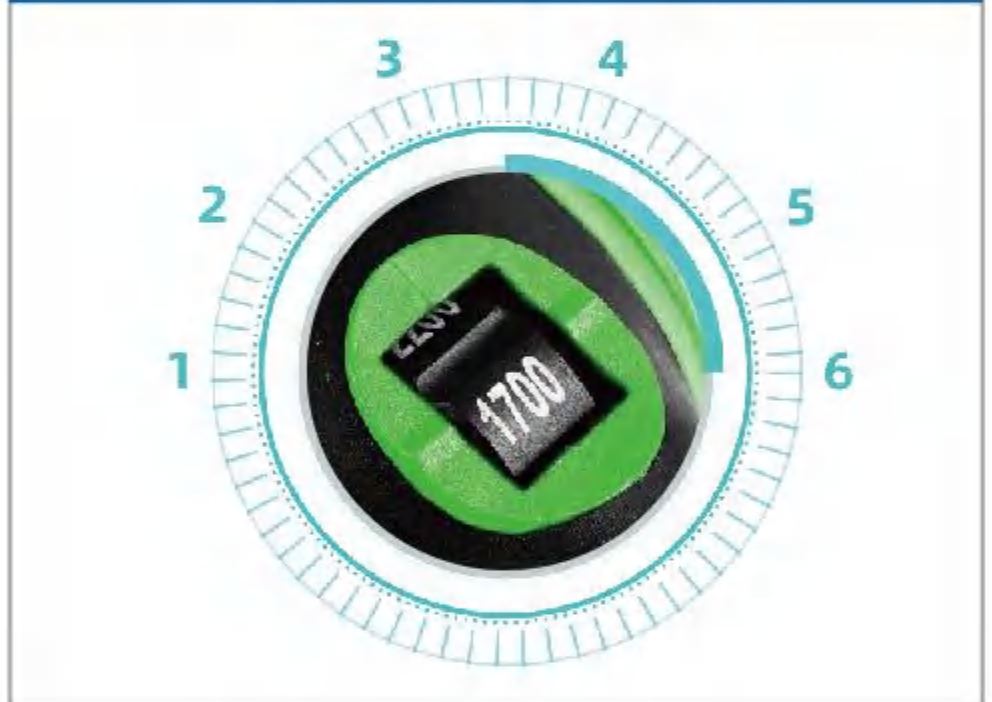

Control with big button 600-3200 RPM  
To meet various working conditions

**ITEM NO.: RP1300**

<b>Rated Voltage:</b> 110-240V AC	<b>Input:</b> 1300W
<b>No Load Speed:</b> 600-3200 RPM	<b>Disc Size:</b> 178mm/7"
<b>Spindle Thread:</b> 5/8" or M14	
Dimensions and weight: 19.69in (L) x 8.27in (W) x 6.3in (H), 7.28lbs	
Package including: PU Hook & Loop Backing Plate, Wool Hood, Wrench, Carbon Brush, Manual, D Handle, Side Handle.	



# MINI CORDLESS POLISHER V2

## BASIC INSTRUCTIONS



### PACKAGE INCLUDING:



## MS-MP0312 V2

**Features:**  
 Lightweight and compact  
 Dual Action and Rotary capability  
 1.5" & 2" backing plates included,  
 as well as rotary extension bars  
 2 battery packs provide continuous use

**Specifications:**  
 80W Mini Cordless Polisher  
 Rotary, 3mm, 12mm orbit DA polisher  
 6 Speed Settings (2000-4700RPM)  
 Digital Screen for battery life  
 2 Batteries (2.0Ah)  
 1.5" and 2" Backing Plates  
 Extension Bars Included

**Included Polishing Pads:**  
 5x 1.5" Yellow Polishing Pads  
 5x 1.5" Red Finishing Pads  
 5x 1.5" Wool Cutting Pads  
 5x 1.5" Blue Microfiber Pads  
 5x 2" Yellow Polishing Pads  
 5x 2" Red Finishing Pads  
 5x 2" Wool Cutting Pads  
 5x 2" Blue Microfiber Pads



Insert wrench into output shaft, then rotate eccentricity seat to install the entire eccentric part as shown in figure 1.



Then install protection cover as shown in figure 2.



Insert wrench into flat square shaft, and then rotate polishing pad. This way you can easily install all the polishing heads.



**Battery Pack Button**

**Warning:**  
 Be sure to disconnect the power when installing or replacing the polishing head.



## MINI POLISHING SYSTEM



## MS-MN01

**Cable: 1.5m Thread: M14 or 5/8"**

The MN01 is designed to be used in tight areas like car headlamps, fog lights, brake lights, door handles, emblems, glass, interior console panels and other small areas.

The universal locking mechanism makes it extremely easy to lock-in all of your favorite accessories. Specifically designed for polishing small areas, the MN01 is proficient in gently removing debris, scratches and other surface imperfections on the recessed areas of your vehicles.

A variety of mini-custom accessories is included that allows you to work on different surfaces. It comes equipped to connect to a 5/8" or M14 connector – which are the industry standard outputs for rotary polishers.



Including	Red Finishing Pad	Green Polishing Pad	Felt Polishing Pad	Long Wool Pad	Orange Polishing Pad
	Ø 1.5x1cm(3pc) Ø 2.6x1.2cm(3pc)	Ø 1.5x1cm(3pc) Ø 2.6x1.2cm(3pc)	Ø 1.5x0.5cm(3pc)	Ø 2.5cm(3pc)	Size: 3x4.5cm(3pc)
	Orange Polishing Pad	Backing Pad	Adaptor M14 or 5/8"	Small Wrench	Small Bag
	Size: 3x3cm(3pc)	Ø 1.5cm(1pc) Ø 2.5cm(1pc)	1pc	1pc	1pc
	Polishing Machine, Rubber 1.5m				

# BACKING PLATES

Distributes pressure evenly for optimum defect removal with a high-speed DA polisher  
 10mm thickness of the Polyurethane provides durability from heat and pressure.  
 The flexible backing plate is ideal for all brands of Dual Action polishing machines with a 5/16" diameter thread.  
 The hook and loop backing plate grips all pad types, ensuring pads stay centered and balanced.  
 The vented design offers fresh air to help cool the backing plate and extend durability.  
 It can be used more than 10,000 times.

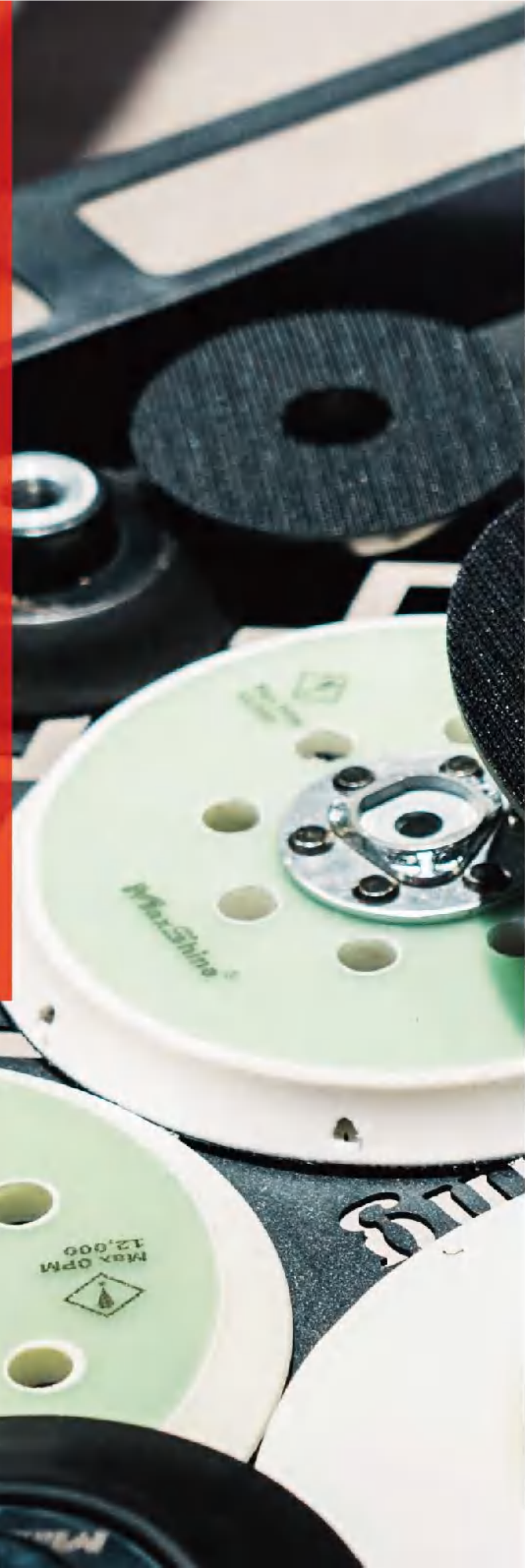

## DA PLATE BACKING PAD



### DA Backing Plate



ITEM NO. MS-PBP125-L 5" (Ø125mm)  
 ITEM NO. MS-PBP150-L 6" (Ø150mm)

Thread 5/16" -24

### 8/9mm Orbit DA Backing Plate



ITEM NO. MS-BP125  
 ITEM NO. MS-BP125-H 5" (Ø 125mm)  
 ITEM NO. MS-BP150  
 ITEM NO. MS-BP150-H 6" (Ø 150mm)

### DA Backing Plate For Polisher



ITEM NO. MS-PBP50 2" (Ø 50mm)  
 ITEM NO. MS-PBP75 3" (Ø 74mm)  
 ITEM NO. MS-PBP75-B 3" (Ø 74mm)  
 ITEM NO. MS-PBP75-BH(6 holes) 3" (Ø 74mm)



ITEM NO. MS-MBP125 5" (Ø 125mm)  
 ITEM NO. MS-MBP150 6" (Ø 150mm)  
 Thread: 5/16"-24, Max OPM:12000

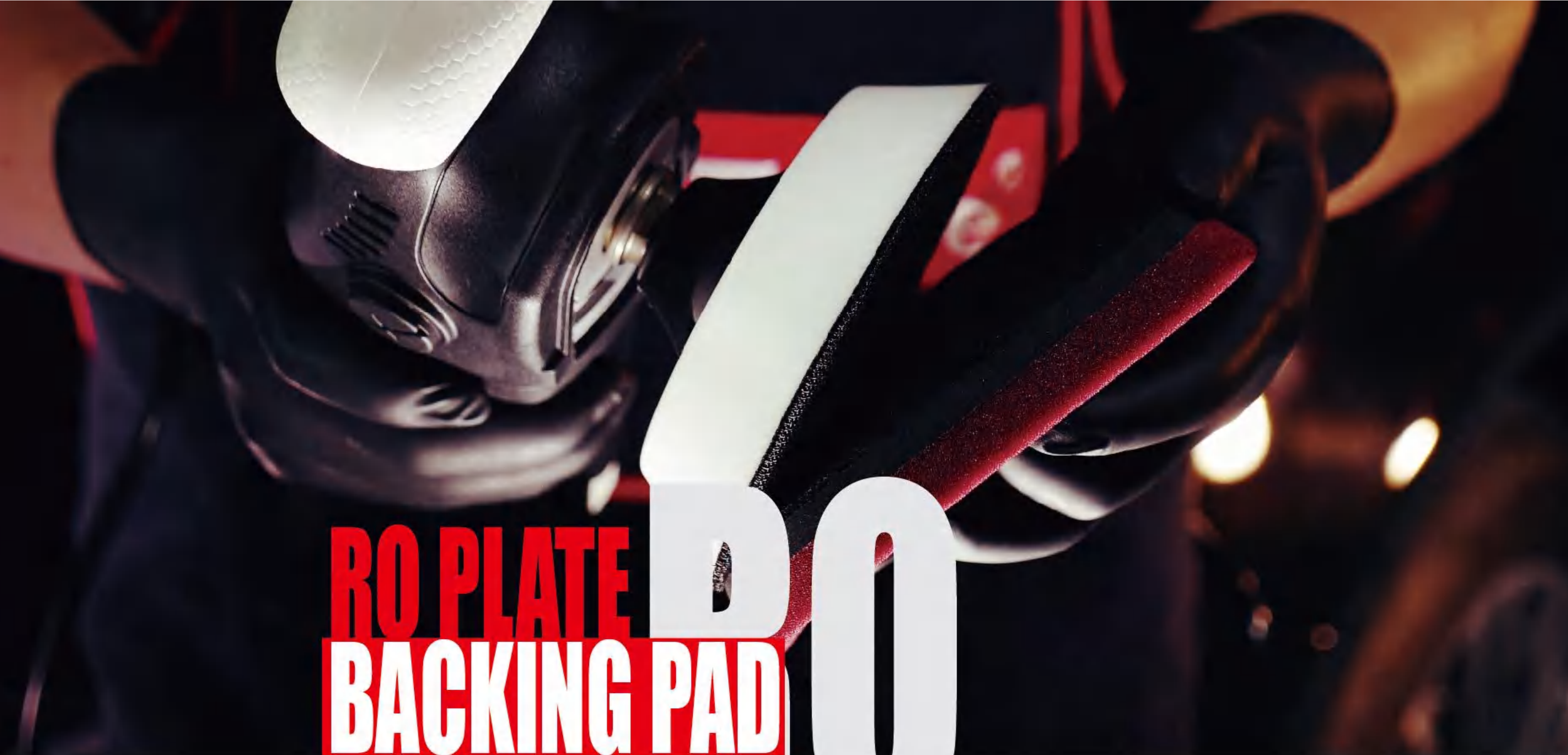

# RO PLATE PRO BACKING PAD



## Rotary Polisher Backing Plates

Material:  
Imported PU with soft edge which protect the painted surface safer.  
Hook & loop: velcro Color: white or yellow  
Thread: M14 or 5/8"

ITEM NO.	DIAMETER	THREAD	THICKNESS	MAX.RPM
MS-PU01-50	2" (50mm)	5/8,M14	22mm	12000
MS-PU01-70	3" (70mm)	5/8,M14	22mm	12000
MS-PU01-125	5" (125mm)	5/8,M14	27.5mm	8000
MS-PU01-150	6" (150mm)	5/8,M14	27.5mm	8000

## Rotary Backing Plate

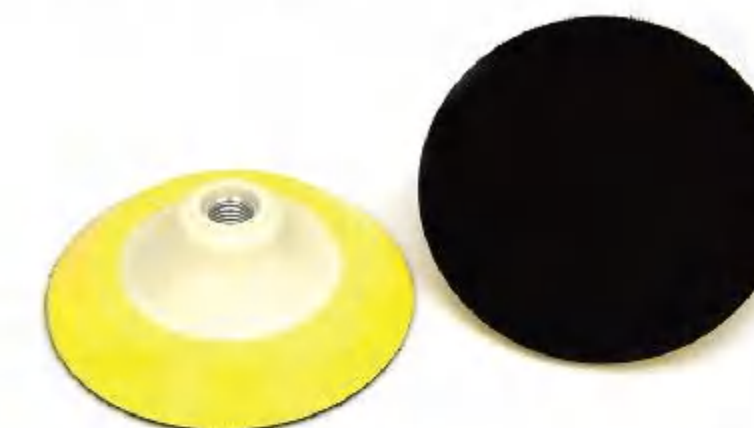

ITEM NO. MS-PU04-100 4" (Ø100mm)  
ITEM NO. MS-PU04-115 4.5" (Ø115mm)  
ITEM NO. MS-PU04-125 5" (Ø125mm)  
ITEM NO. MS-PU04-150 6" (Ø150mm)  
ITEM NO. MS-PU04-180 7" (Ø180mm)  
ITEM NO. MS-PU04-200 8" (Ø200mm)  
PU Thickness: 15.5mm Thread: M14 or 5/8"

## Backing Plate Pad



ITEM NO. MS-PU09-075 3" (Ø75mm)  
ITEM NO. MS-PU09-125 5" (Ø125mm)  
ITEM NO. MS-PU09-150 6" (Ø150mm)  
ITEM NO. MS-PU09-178 7" (Ø178mm)  
PU Thickness: 10mm Thread: M14 or 5/8"

## Flexible Backing Plate For Rotary Polisher



ITEM NO. MS-PU10-125 5" (Ø125mm)  
ITEM NO. MS-PU10-150 6" (Ø150mm)  
PU Thickness: 21mm Thread: M14 or 5/8"

## Rotary Backing Pad



ITEM NO. MS-PU07-30 1.2" (Ø30mm)  
ITEM NO. MS-PU07-50 2" (Ø48mm)  
ITEM NO. MS-PU07-70 3" (Ø74mm)  
PU Thickness: 12mm Thread: M14 or 5/8"

# PREMIUM MICROFIBER TOWEL

A car detailing program is worthless if it adds swirl marks and scratches to your freshly polished paint. Premium Microfiber Towels & Applicators are the finest available anywhere and will not scratch your paint. Guarantee!

Easier to use, softer and safer Microfiber Towels!

Weight Range: 180GSM-1200GSM.

Material: 80% Polyester, 20% Polyamide.

Edging Options: Satin/PE Border/Sewn/Edgeless.

Customized Size/Packing/Label/Colors is available!



**PREMIUM HEAVY  
DUTY DETAILING CART**

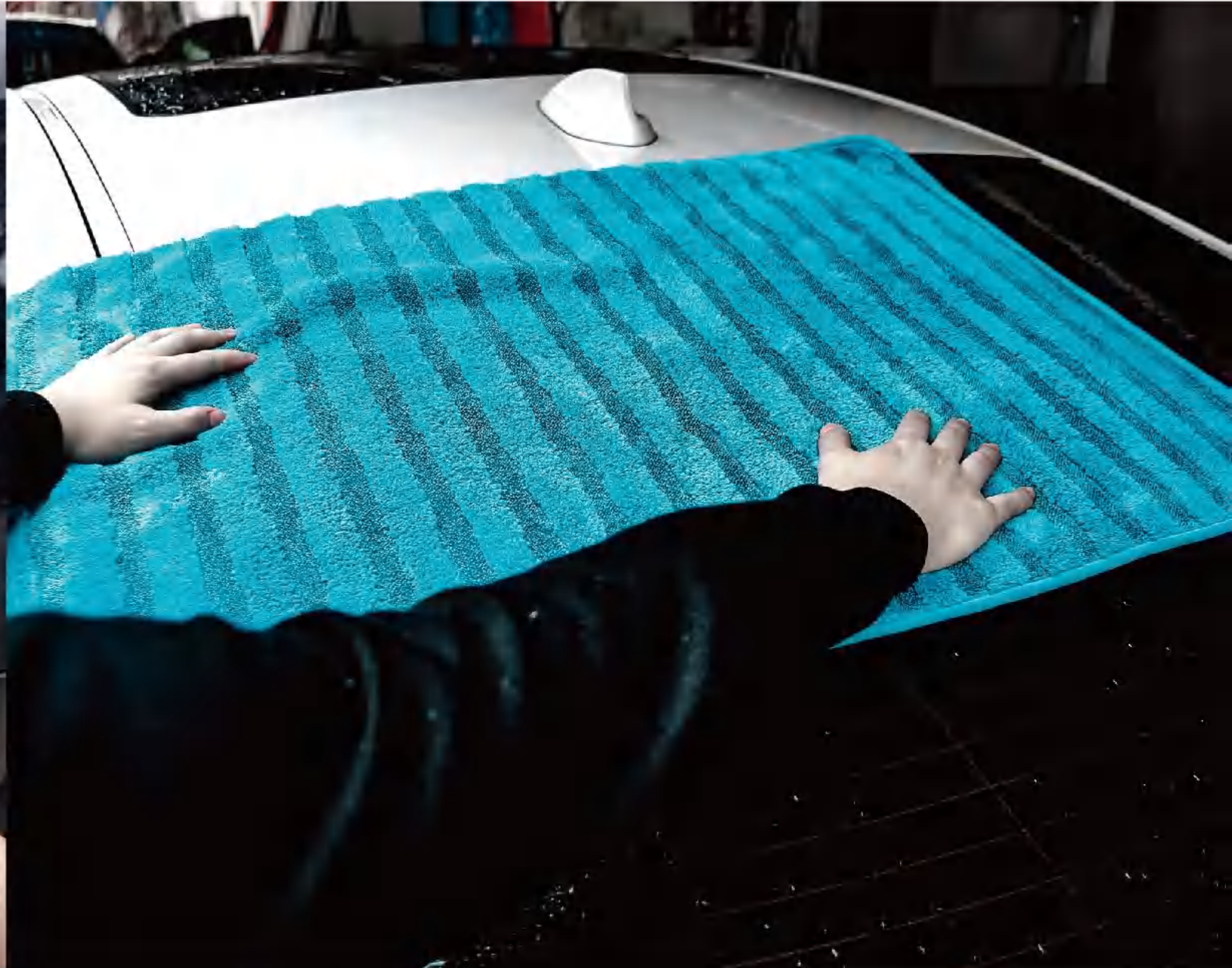

## EDGELESS PLUSH MICROFIBER TOWEL

Both Sides Are Plush High Pile Loop

ITEM NO. MS-EPT4040 / MS-EPT4060

Thickness: 350-1300g/m<sup>2</sup>

Material: 80% Polyester, 20% Polyamide

Size: 16x16", 16x24"



High Density Soft,  
Super Water Absorption.



Edgeless



Lint-free 100% Scratch Free

## T&p Super Drying Towel

ITEM NO. MS-TP7590

Thickness: 1000g/m<sup>2</sup>

Material: 80/20 Blend Split Microfiber

Size: 15x24", 20x30" 24x36" and 30x36"

The Customized size/color are available

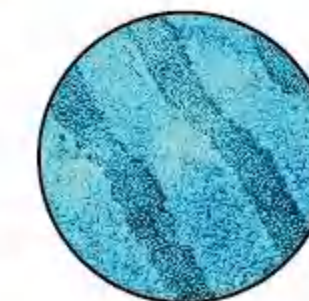

High Density Soft,  
Super Water Absorption.

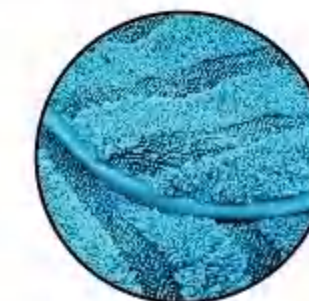

Soft Border

## DUO TWISTED SUPER DRYING TOWEL

Double Side Twisted Loop

ITEM NO. MS-DTT6090

Thickness: 1200g/m<sup>2</sup>  
Material: 80/20 Blend Split Microfiber  
Size: 15x24", 20x30" and 24x36"



Unique supersoft microfiber



Rounded corners trimmed with bound-in satin edging



## TWISTED WITH PLUSH DRYING TOWEL

ITEM NO. MS-DTC6090 / MS-DTS6090

Thickness: 1200g/m<sup>2</sup>  
Material: Duo Twisted and Coral Velvet  
Size: 24" x36"



Ultimate plush microfiber



Duo Twisted and Coral Velvet double sided



## MICROFIBER TEAR AWAY TOWEL ROLL

ITEM NO. MS-MTR3030

Thickness: 260gsm  
Blend: 80% Polyester, 20% Polyamide  
Material: Terry Pile  
Size: 12" x12" (30X30cm)  
Pack Qty: 30 sheets per roll.





## PLUSH MICROFIBER TOWEL

Both Sides Are Plush High Pile Loops

ITEM NO. MS-PT4040 / MS-PT4060

Thickness: 350-1300g/m<sup>2</sup>

Material: 80% Polyester, 20% Polyamide Size: 16x16", 16x24"

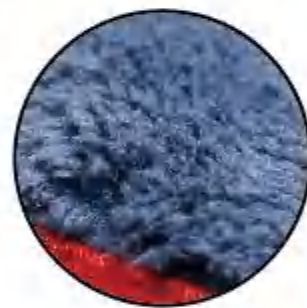

High Density Soft,  
Super Water Absorption.



Soft PE Border

## MICROFIBER WAFFLE DRYING TOWEL

Perfect For Drying

ITEM NO. MS-WT4060 / ITEM NO. MS-WT6090

Thickness: 400-450g/m<sup>2</sup>

Material: 80% Polyester, 20% Polyamide Size: 16x24", 24x36"

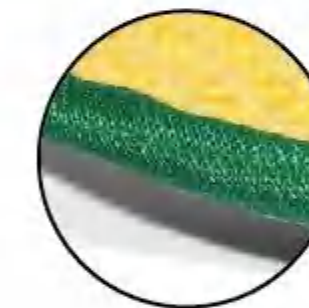

Satin Sewing



Waffle Weave  
Super Water Absorption



## WONDER GLASS CLEANING TOWEL

ITEM NO. MS-WGC4040 / ITEM NO. MS-WGC4060

Thickness: 220gsm with 2mm foam

Material: Microfiber+Foam Size: 16x16", 16x24"

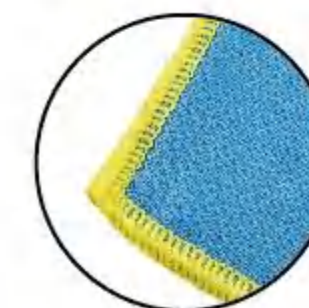

Overlock Stitching  
Prevents fraying

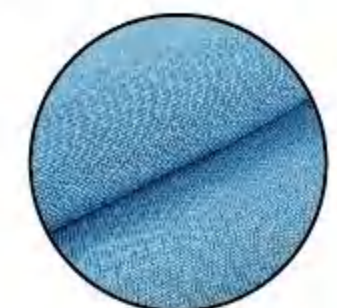

Sponge Blend Microfiber  
superior absorption & lint-free or streaks-free



### Orange Thick Drying Towel

Both Sides Are Plush High Pile Loops

ITEM NO. MS-PT4040-E / MS-PT4060-E

Thickness: 400-1200g/m<sup>2</sup>  
 Material: 80% Polyester, 20% Polyamide  
 Size: 40x40" / 40x60"

### Plush Microfiber Towel

Both Sides Are Plush High Pile Loops

ITEM NO. MS-PT5070-D / MS-PT4560-D



Thickness: 400-1300g/m<sup>2</sup>  
 Material: 80% Polyester, 20% Polyamide Size: 20x28"

### Edgeless Ultra Microfiber Towel

Both Sides Are Short Pile Loops

ITEM NO. MS-EUT4040 / MS-EUT4060



Thickness: 200-450g/m<sup>2</sup>  
 Material: 80% Polyester, 20% Polyamide  
 Size: 16x16", 16x24"

### Double Color Microfiber Towel

Both Sides Are Plush High Pile Loops

ITEM NO. MS-PT4040-B / MS-PT4060-B

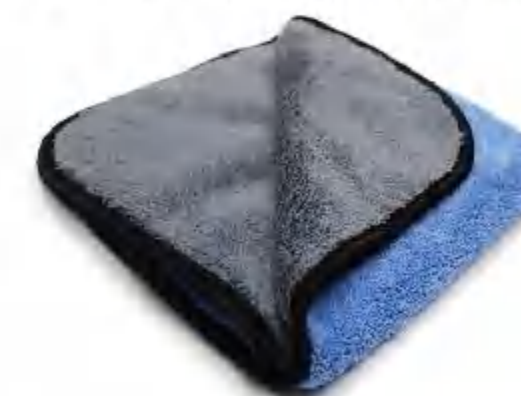

Thickness: 350-1300g/m<sup>2</sup>  
 Material: 80% Polyester, 20% Polyamide  
 Size: 16x16", 16x24"

### Ultra Microfiber Towel

Both Sides Are Short Pile Loops

ITEM NO. MS-UT4040 / MS-UT4060 / MS-UT6090



Thickness: 200-500g/m<sup>2</sup>  
 Material: 80% Polyester, 20% Polyamide  
 Size: 16x16", 16x24", 24x36"



**Green Microfiber Glass Scrubbing Towel**

**ITEM NO. MS-GMT3535**  
 Size: 35x35cm  
 Weight Range: 400-1200GSM  
 Material: 80% Polyester, 20% Polyamide,  
 Two-Sided Glass Cleaning Towel



**Glass Microfiber Towel**

**ITEM NO. MS-GCMT4040**  
 Size: 40x40cm  
 Thickness: 350-1300g/m  
 Material: 80% Polyester, 20% Polyamide

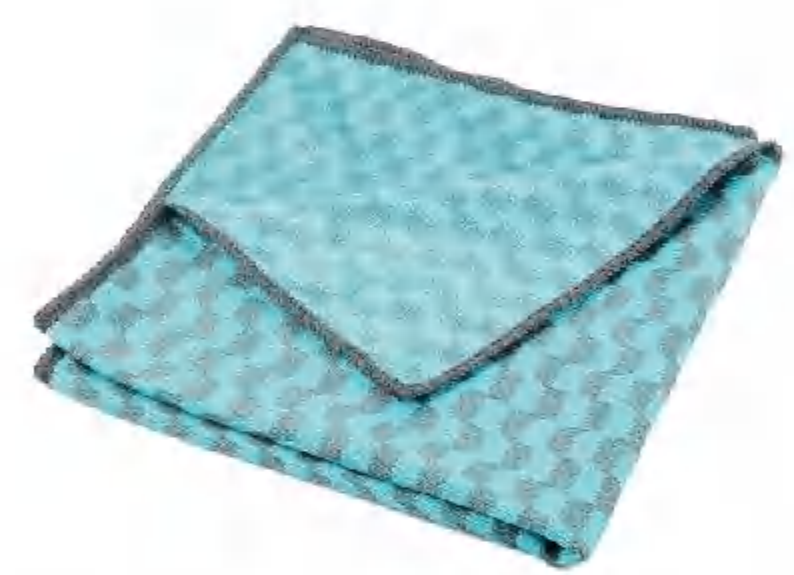

**Ultra-Compact Microfiber Towel**

**ITEM NO. MS-UMT4040**  
 Size: 40x40cm  
 Thickness: 350-1300g/m<sup>2</sup>  
 Material: 70% PET, 30% PA



**Microfiber Towels For Streak-Free Drying And Polishing**

**ITEM NO. MS-DMT4060**  
 Size: 40x60cm  
 Thickness: 220-1300g/m<sup>2</sup>  
 Material: 80% Polyester, 20% Polyamide

**Dual-Sided Twisted Loop & Waffle Weave Drying Towel**

**ITEM NO. MS-TLW4040 / MS-TLW6090**  
 Size: 40x40cm / 60x90cm  
 Thickness: Orange Twisted 600GSM, Tiffany Blue Waffle 380GSM

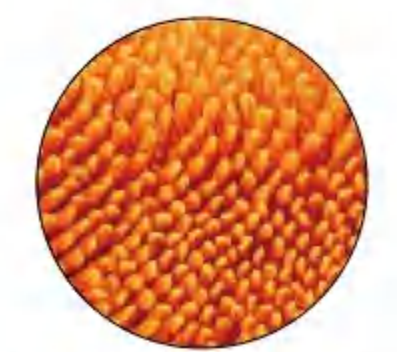

Twisted loop for fast drying

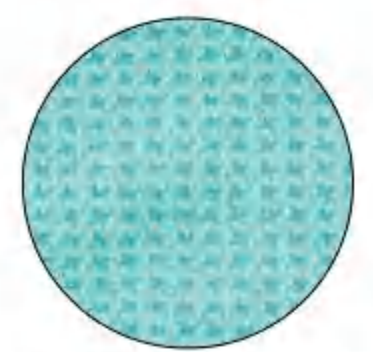

Waffle weave for flawless buffing



### Microfiber Suede Towel

Perfect For Coating

ITEM NO. MS-ST4040 / MS-ST4060

Thickness: 180-220g/m<sup>2</sup>

Material: 80% Polyester, 20% Polyamide

Size: 16x16", 16x24"



### Twisted Loop Drying Towel

ITEM NO. MS-TL4040 / MS-TL4060 / MS-TL6090

Thickness: 500g/m<sup>2</sup>

Material: 70% Polyester, 30% Polyamide

Size: 16x16", 16x24", 24x36"



Silk Border

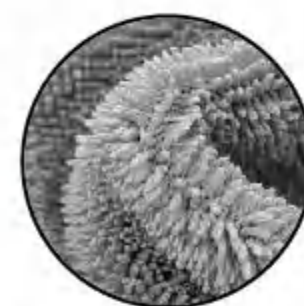

Fluffy fiber, lint-free, scratch-free, high water absorption.

### Gold Plush Microfiber Towel

One Side is Short Pile Loop, The Other Side is High Pile Loop

ITEM NO. MS-CGT4040 / MS-CGT4060



Thickness: 250-550g/m<sup>2</sup>

Material: 80% Polyester, 20% Polyamide

Size: 16x16", 16x24"

### Edgeless Microfiber Cobra Towel

One Side is Short Pile Loop, The Other Side is High Pile Loop

ITEM NO. MS-ECT4040 / MS-ECT4060



Thickness: 250-550g/m<sup>2</sup>

Material: 80% Polyester, 20% Polyamide

Size: 16x16", 16x24"



### Carbon Fiber Towel

Perfect For Clean Glass  
**ITEM NO. MS-CGT4040-B / MS-CGT4060-B**  
 Thickness: 360g/m<sup>2</sup>  
 Material: 70% polyester, 15% carbon, 15% polyamide  
 Size: 40x40", 40x60"



### Glass Microfiber Towel

Perfect For Clean Glass  
**ITEM NO. MS-GMT4040 / MS-GMT4060**  
 Thickness: 250-350g/m<sup>2</sup>  
 Material: 80% Polyester, 20% Polyamide  
 Size: 16x16", 16x24"



### Edgeless Pearl Microfiber Towel

Perfect For Polishing  
**ITEM NO. MS-EBPT4040 / MS-EBPT4060**  
 (Edgeless Style)  
**ITEM NO. MS-BPT4040 / MS-BPT4060**  
 (Sewn Style)  
 Thickness: 330-350g/m<sup>2</sup>  
 Material: 80% Polyester, 20% Polyamide  
 Size: 16x16", 16x24"



### Cloudforce Car Wash Wash Drying Towel

ITEM NO. MS-CF4545

Size: 44x46 cm

Weight: 900 GSM

Material: CloudForce Microfiber



### Twisted & CloudForce Car Wash Drying Towel

ITEM NO. MS-TCF7090

Size: 71x88 cm

Weight: 900 GSM

Material: Twist Loop Weave+CloudForce Microfiber



### PVA Synthetic Chamois

ITEM NO. MS-PVA4366 Size: 43x66cm

ITEM NO. MS-PVA3243 Size: 32x43cm

Absorbs water 3x faster than a regular towel or chamois



Flat Style



Waffle



### PVA Synthetic Chamois

ITEM NO. MS-PVA4366W Size: 43x66cm

ITEM NO. MS-PVA3243W Size: 32x43cm



### Microfiber Wheel Scrubbing Belt

ITEM NO. MS-WWS01

Thickness: 700gsm Size: 74x7x2.5cm

Material: Microfiber with Nylon Ribbon

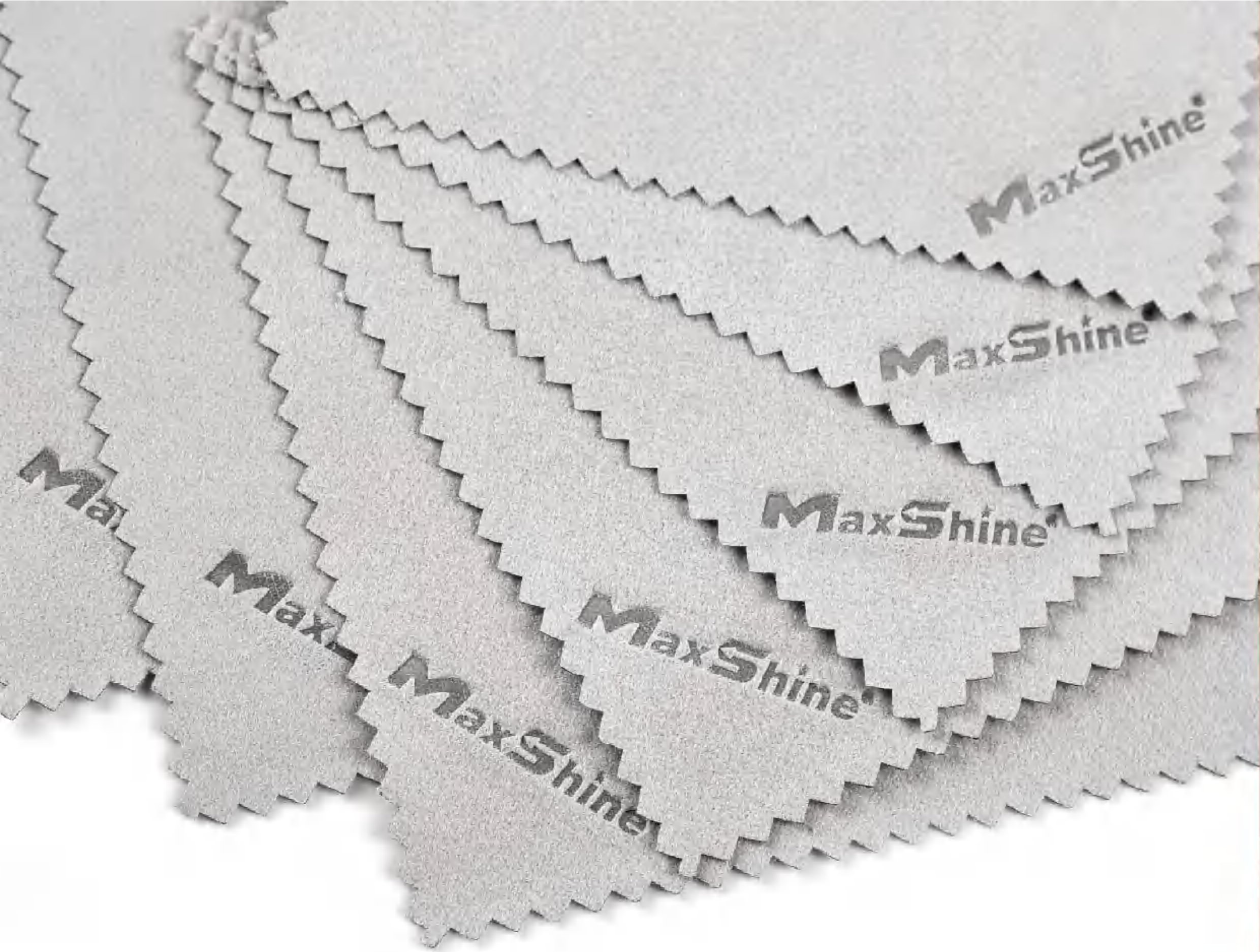

**Suede Microfiber  
Detailing Coating Cloth**

ITEM NO. MS-MDC1010  
 thickness: 200gsm    size: 10x10cm(4"x4")



**Microfiber Detailing Apron**

ITEM NO. MS-MDA01  
 thickness: 250-350g/m<sup>2</sup>    80% Polyester, 20% Polyamide  
 Waterproof Back    PE Border, soft, safe



**Microfiber Detailing Apron**

ITEM NO. MS-MDA02  
 thickness: 500g/m<sup>2</sup>    80% Polyester, 20% Polyamide  
 Size: 77cmx89cm    Double coral velvet

# PREMIUM MICROFIBER WASH MITT

Microfiber cleaning mitts by Maxshine are soft and effective to wash your car without any scratches. Maxshine wide selection of car detailing products offers you fast and easy cleaning or washing work. Wash mitt is an effective and useful way to care for your car.





## Plush Microfiber Wash Mitt

ITEM NO. **MS-PWM08**

Material: 92% Polyester, 8% Viscose

Features: Soft Plush Microfiber, Thick Pile Perfect cleaning,  
Super Water Absorption.

Size: 28x20cm



High Density with better  
elasticity



Soft Plush Microfiber,  
Thick Pile Perfect cleaning,  
Super Water Absorption.



## Plush Microfiber GLOVES

ITEM NO. MS-PWM14

Material: Ultra Soft Plush Microfiber

Features: Avoids Leaving Oils from Hand and Finger Prints.

Washable and Re-Usable.

Size: One size fits all (12 x 20.5cm )



High Density with better elasticity



Pairs with Microfiber Safe Soap Form-Fitting



**Ultra-plush Microfiber  
Car Wash Mitt with Thumb**

ITEM NO. MS-PWM19

Size: 280x190mm



**Ultra-Plush Microfiber  
Car Wash Mitt**

ITEM NO. MS-PWM20

Size: 280x190mm



**Ultra-Plush Microfiber  
Car Wash Sponge**

ITEM NO. MS-CCP12

Size: 238x128x74mm



**Plush Microfiber  
Thumb Gloves**

ITEM NO. MS-PWM09  
Size: 29x21cm



**Microfiber  
Wash Glove**

ITEM NO. MS-PWM10  
Size: 30x(12-26)cm



**Microfiber Plush  
Wash Mitt**

ITEM NO. MS-PWM01  
Size: 28x22cm



**Plush Chenille  
Wash Mitt**

ITEM NO. MS-PWM05  
Size: 24x17cm



**Chenille Microfiber  
Wash Mitt**

ITEM NO. MS-PWM06  
Size: 24x17cm  
Customized color for the back side is available  
Material:80% Polyester,20% Polyamide



**Plush Microfiber  
Colorful Wash Mitt**

ITEM NO. MS-PWM13  
Size: 28cmx18.5cm (11.02"x7.28")



**Duo Twisted  
Wash Mitt**

ITEM NO. MS-PWM17  
Size: 23x18x2cm  
Material:Microfiber



**Microfiber  
Wash Mitt**

ITEM NO. MS-PWM15  
Size: 23.5x19x2cm  
Material:Microfiber



**Microfiber With Waffle  
Wash Mitt**

ITEM NO. MS-PWM12  
Size: 28cmx18cm (11.02"x7.09")



**Chenille Wash Mitt**

ITEM NO. MS-PWM16  
Size:26x20x5cm  
Material:Double Sides Chenille

# PREMIUM MICROFIBER WASH PAD

Car washing pads save you time and effort during your journey of car detailing. Maxshine offers you with variety of car washing pads to suit your needs.





## Microfiber Wash Pad

ITEM NO. MS-CCP06

Size: 23x17cm

Material: 92% Polyester, 8% Viscose  
Plush Microfiber Long Pile ,Quality Reliable Sponge  
Plush Chenille Microfiber ,Lint-Free, Easy to remove  
dirt from car.Enjoy Car Detailing.



Soft Plush Microfiber,  
Thick Pile Perfect cleaning,  
Super Water Absorption.



ITEM NO. MS-CCP01  
Size: 22.5x12.5x5.5cm



ITEM NO. MS-CCP02  
Size: 22x11x5.5cm



ITEM NO. MS-CCP07  
Size: 23x(8.5-10.5)x5cm



ITEM NO. MS-CCP08  
Size: 22.5x(8.5-10.5)x5.5cm



ITEM NO. MS-CCP10  
Size: 18.5x(8.5-13.5)x(0.5+5.5)cm



ITEM NO. MS-CCP11  
Size: 26 x 19.5cm



ITEM NO. MS-CCP03  
Size: 21x11x5.5cm



ITEM NO. MS-CCP09  
Size: 22x17cm



ITEM NO. MS-CCP04  
Size: 20x12x6cm or 12x10x3.5cm





# SHEEPSKIN NATURAL WASH MITT

Wool mitt is premium quality for cleaning your car surface easily and comfortably removing stain, grime, or dirt. Comfortable design and durability make this one of the best sheepskin mitts & pad on the market.

## Finger Wheel Wool Wash Mitt

ITEM NO. MS-WWM09

Size:15x5x14.5cm

Material:100% Genuine Lambs Wool

This Wool Finger Mitt is a four finger wash mitt made from 100% genuine lambs wool. The lambs wool is soft enough to not leave scratches on your paintwork when in use.



## Premium Wool Wash Mitt - Mesh Back

ITEM NO. MS-WWM10

Size: 150x250mm

Material:100% Australian Wool



ITEM NO. MS-WWM07  
Size:240x160mm



## Genuine Sheepskin Wool Wash Mitt

ITEM NO. MS-WWM08

Size: 30x20cm

Material:100% Sheepskin Wool



ITEM NO. MS-WWM01  
Size: 300x200mm



ITEM NO. MS-WWM05  
Size: 300x200mm



ITEM NO. MS-WWM02  
Size: 300x230mm



ITEM NO. MS-WWM06  
Size: 180x260mm



ITEM NO. MS-WWM03  
Size: 350x160mm



ITEM NO. MS-WWP01  
Size: 230x230mm



ITEM NO. MS-WWM04  
Size: 110x90mm



ITEM NO. MS-WWP02  
Size: 230x230mm





# SCRUB NINJA SPONGE

Scrub interior vehicle surfaces like plastic, leather and vinyl clean with the brush-like, bristle-type fabric on this nylon sponge scrubber. The firm but gentle fibers scrub deep into fabric pours and contours. **AGGRESSIVE BUT GENTLE CLEANING** – The stiff nylon bristles brush away debris gently and with ease. More aggressive than a microfiber towel but more gentle than a melamine sponge.



Tire Dressing Applicator With Barrier Layer  
**ITEM NO. MS-SNS07**  
 Size: 4in. x 3in. x 2in.  
 Material: 80/20 Blend Twisted Fiber



Scrubbing Block Car Sponge  
**ITEM NO. MS-SNS04**  
 Size: 5 in. x 3 in. x 2 in.  
 Material: 100% Nylon Brush Fabric 80/20 Microfiber Mesh Fabric



Scrub Ninja-Finger Mitt  
**ITEM NO. MS-SNS06**  
 Size: 12x8cm  
 Material: 100% Nylon Brush Fabric 80/20 Microfiber Mesh Fabric



Scrub Ninja – Interior Scrubbing Mitt  
**ITEM NO. MS-SNS03**  
 Size: 8 in. x 6 in.  
 Material: 100% Nylon Brush Fabric 80/20 Microfiber Mesh Fabric



Wedge Scrubber Block  
**ITEM NO. MS-SNS05**  
 Size: 5 in. x 2.5 in. x 2 in.  
 Material: 100% Nylon Brush Fabric 80/20 Microfiber Mesh Fabric



### Interior Scrubbing Sponge

ITEM NO. MS-SNS01  
Size: 13.5x8x2cm

**Material: 100% Nylon Brush Fabric on one side and 80/20 Microfiber on the other**

- All-in-one Scrubbing Sponge removes dirt, dust, fingerprints, and stains from interior surfaces
- Bristle-like fibers reach deep to remove the toughest of stains
- Perfect for leather, vinyl, soft plastics, and upholstery

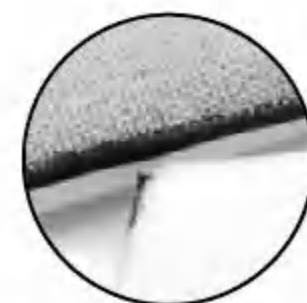

Soft microfibers will apply an even coat of protectant



### Interior Scrubbing Sponge-Duo Bristle Side

ITEM NO. MS-SNS02  
Size: 13.5x8x2cm

**Material: 100% Nylon Bristle on both sides**

- All-in-one Scrubbing Sponge removes dirt, dust, fingerprints, and stains from interior surfaces
- Bristle-like fibers reach deep to remove the toughest of stains
- Perfect for leather, vinyl, soft plastics, and upholstery



Soft microfibers will apply an even coat of protectant



# FOAM POLISHING PAD

Maxshine foam polishing pads are professional designed for the restoration on painted surface and the daily maintenance. The entire series adopt the high quality polyester sponge made in Europe, which possess the advantage of excellent tensile strength and durability, and the service life of which is several times longer than that of the ordinary sponge.

You can select out the appropriate hard or soft foam pad according to the process and the polish/wax being used, and make the most ideal gloss finish on the surface.

P=Polishing C=Cutting F=Finishing

**A** SERIES

**Professional Foam Polishing Pad**

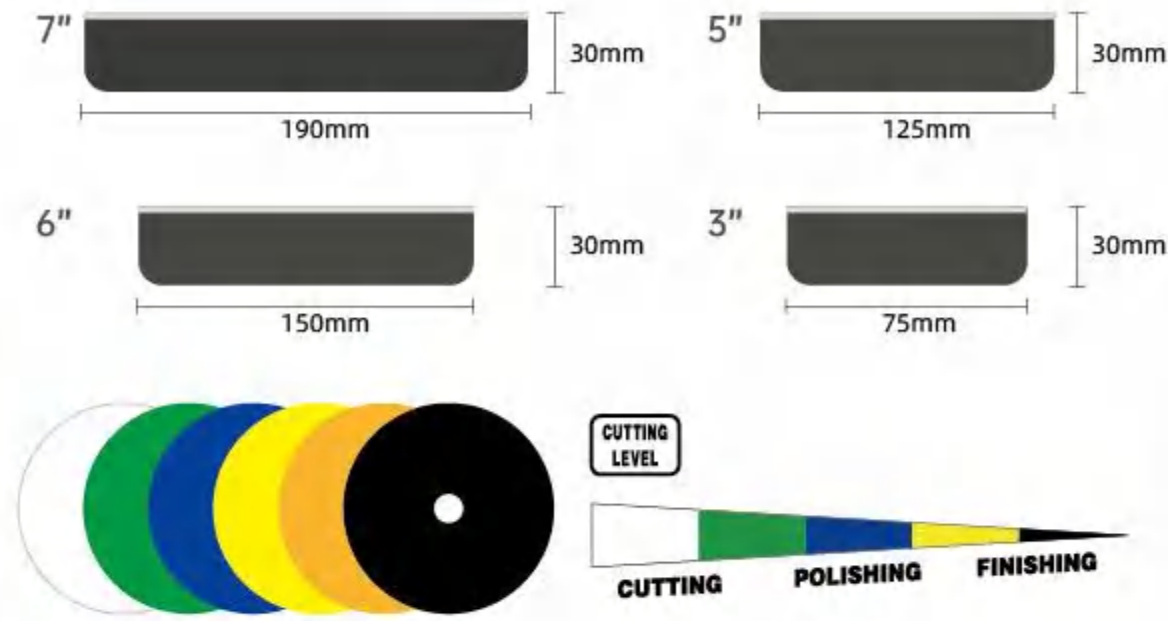

<b>Cutting</b>	Drak Red/Yellow/White/Green/Blue
<b>Polishing</b>	Orange/Yellow/White/Green
<b>Finishing</b>	Green/Blue/White/Red/Black

ITEM NO.	SIZE
A3-75	3" Ø 75x30mm
A5-125	5" Ø 125x30mm
A6-150	6" Ø 150x30mm
A7-190	7" Ø 190x30mm

**D** SERIES

**Cross Cut Foam Pad**

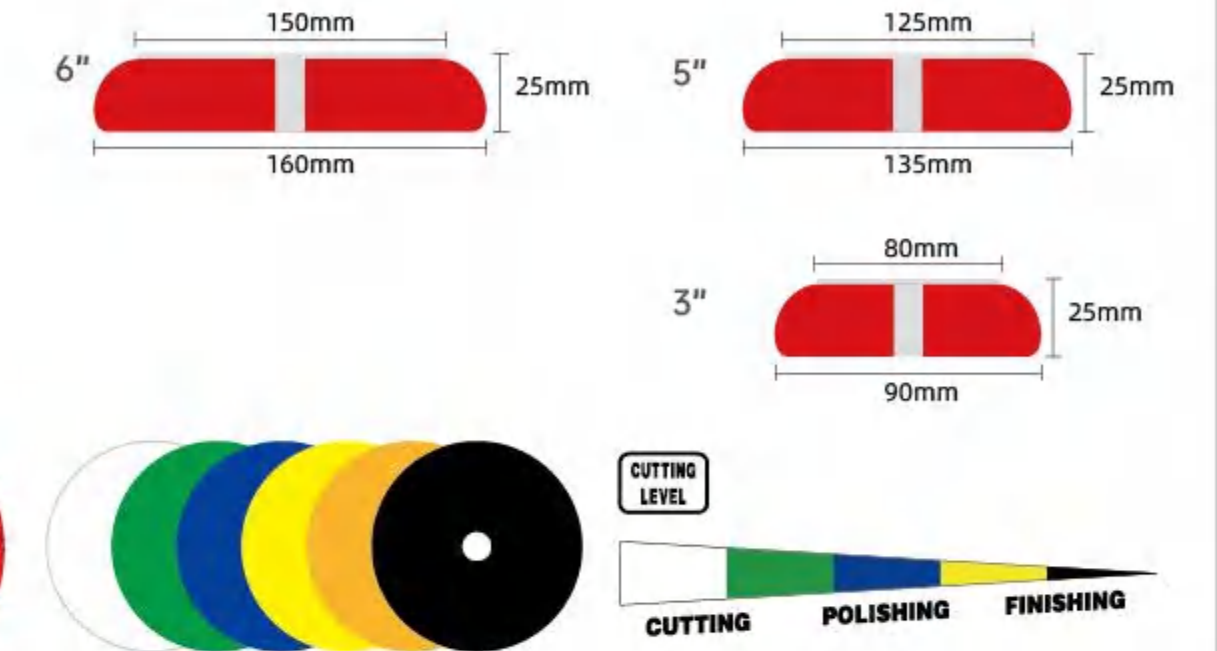

<b>Cutting</b>	Drak Red/Yellow/Blue
<b>Polishing</b>	White/Green
<b>Finishing</b>	Red/Blue/White/Black/Green

ITEM NO.	SIZE
D3-80	3" Ø 80x25mm
D5-125	5" Ø 125x25mm
D6-150	6" Ø 150x25mm

**C** SERIES

**Recessed Backing Foam Polishing Pad**

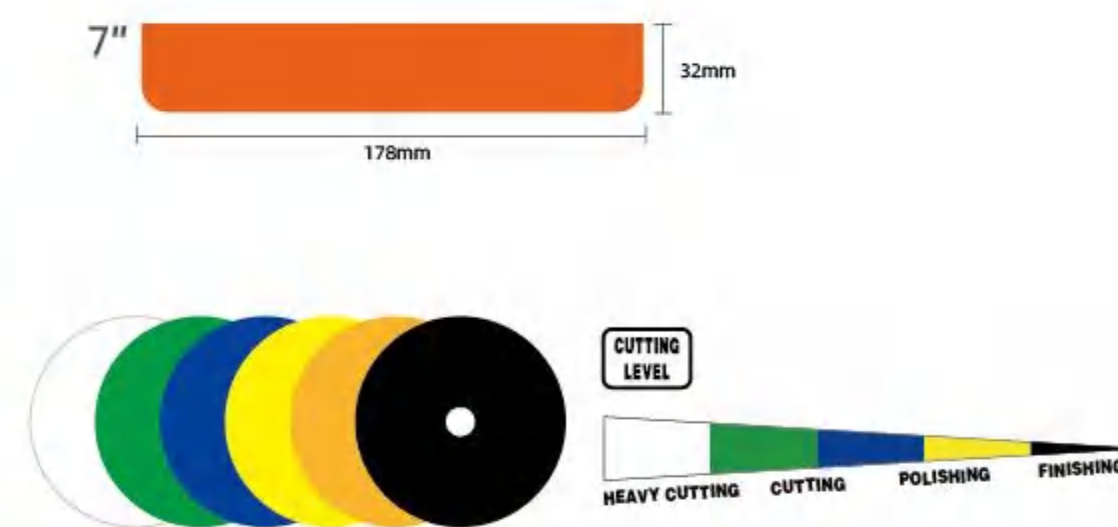

<b>Heavy Cutting</b>	Grey
<b>Cutting</b>	Orange/Dark Red/Yellow
<b>Polishing</b>	Blue/Yellow/Dark Red
<b>Finishing</b>	Blue

ITEM NO.	SIZE
C7-178	7" Ø 178x32 mm

**E** SERIES

**Polishing Corrugated Velcro Foam Pad**

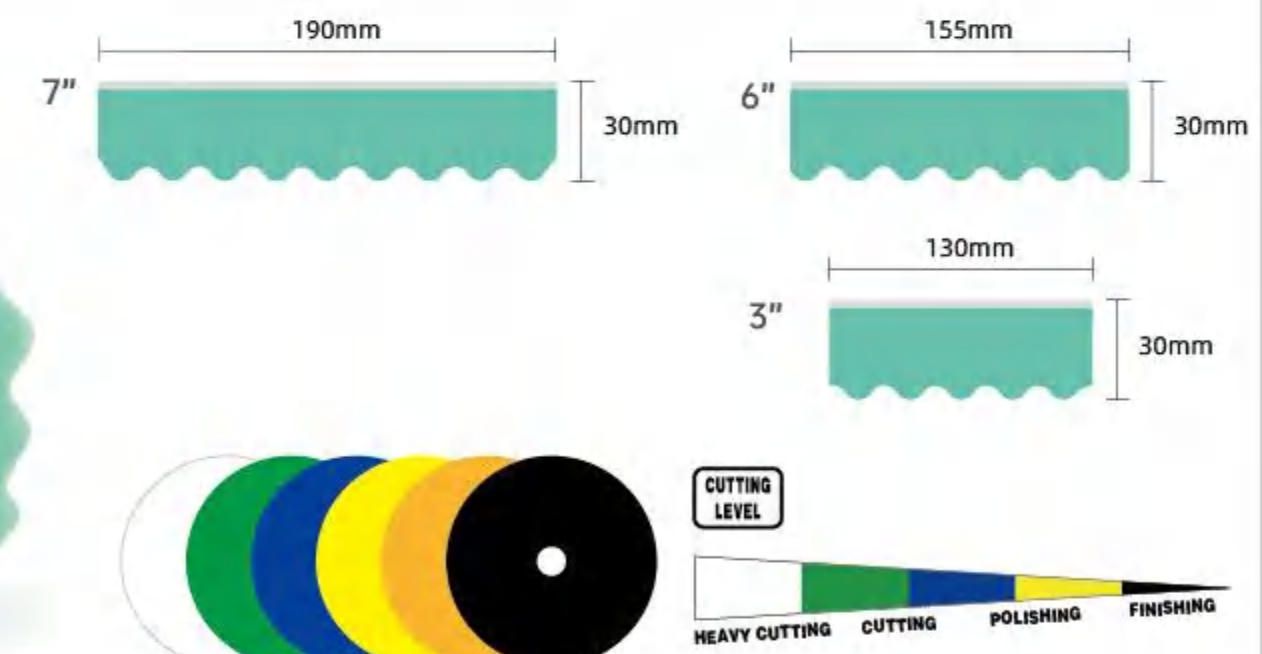
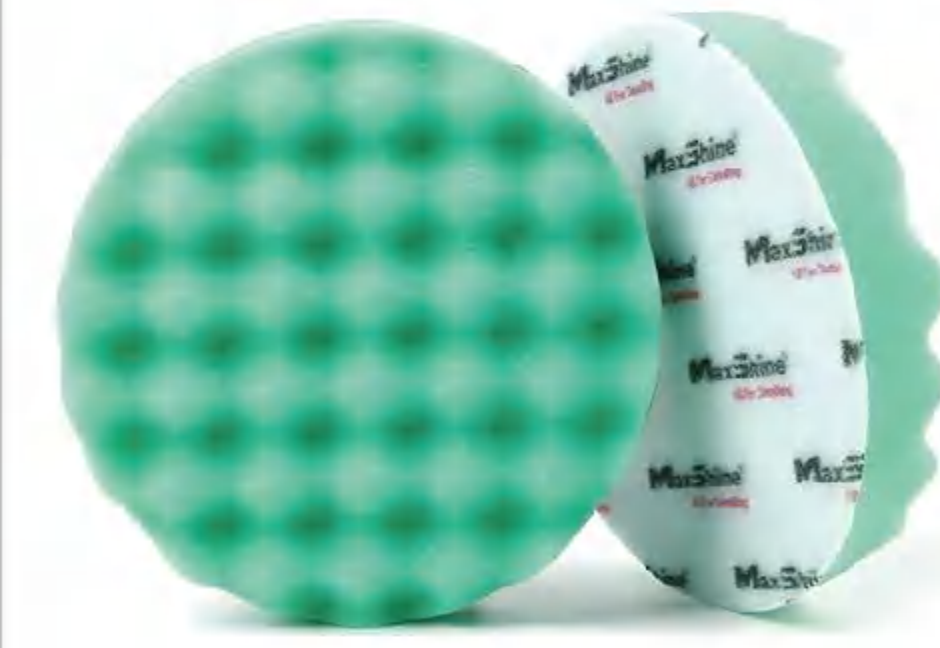

<b>Heavy Cutting</b>	Green/Blue
<b>Cutting</b>	Dark Red/Yellow/Orange
<b>Polishing</b>	Green/Blue/Yellow/Dark Red
<b>Finishing</b>	Green/Blue/Black

ITEM NO.	SIZE
E5-130	5" Ø 130x30mm
E6-155	6" Ø 155x30mm
E7-190	7" Ø 190x30mm

**F** SERIES

**Duo Flat Foam Polishing Pad**

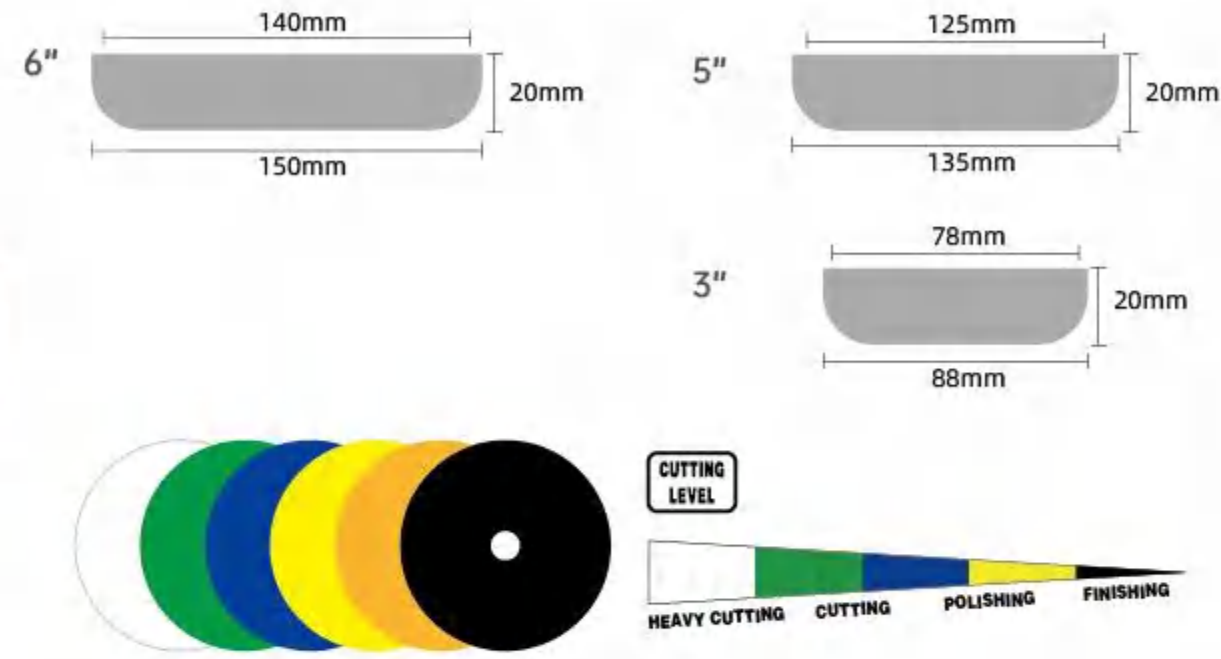

Heavy Cutting	Green/Blue/Grey
Cutting	Dark Red/Yellow/Blue
Polishing	Green/Blue/Yellow/Dark Red/White
Finishing	Green/Blue/White

ITEM NO.	SIZE
F3-78	3" Ø 78x20mm
F5-125	5" Ø 125x20mm
F6-140	6" Ø 140x20mm

**H** SERIES

**Twill Polishing Pads**

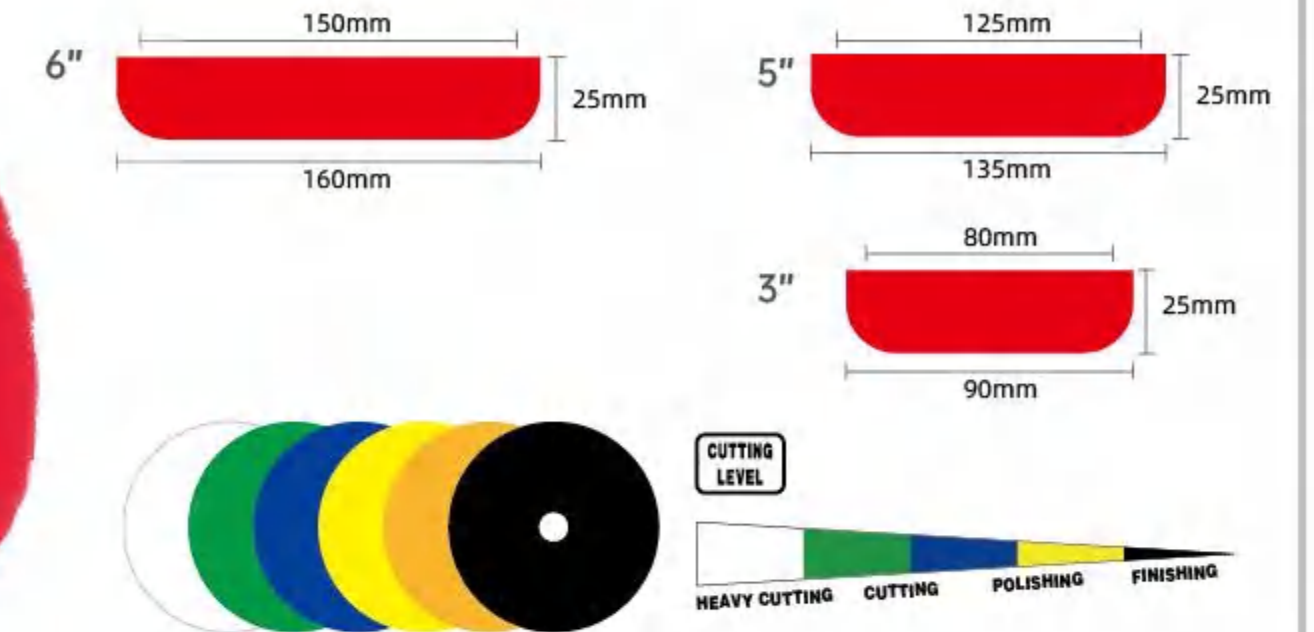

Heavy Cutting	Green/Grey
Cutting	Dark Red/Orange/Red
Polishing	Green/Red/Dark Red
Finishing	Green/Red

ITEM NO.	SIZE
H3-80	3" Ø 80x25mm
H5-125	5" Ø 125x25mm
H6-150	6" Ø 150x25mm

**G** SERIES

**High Pro Foam Polishing Pad**

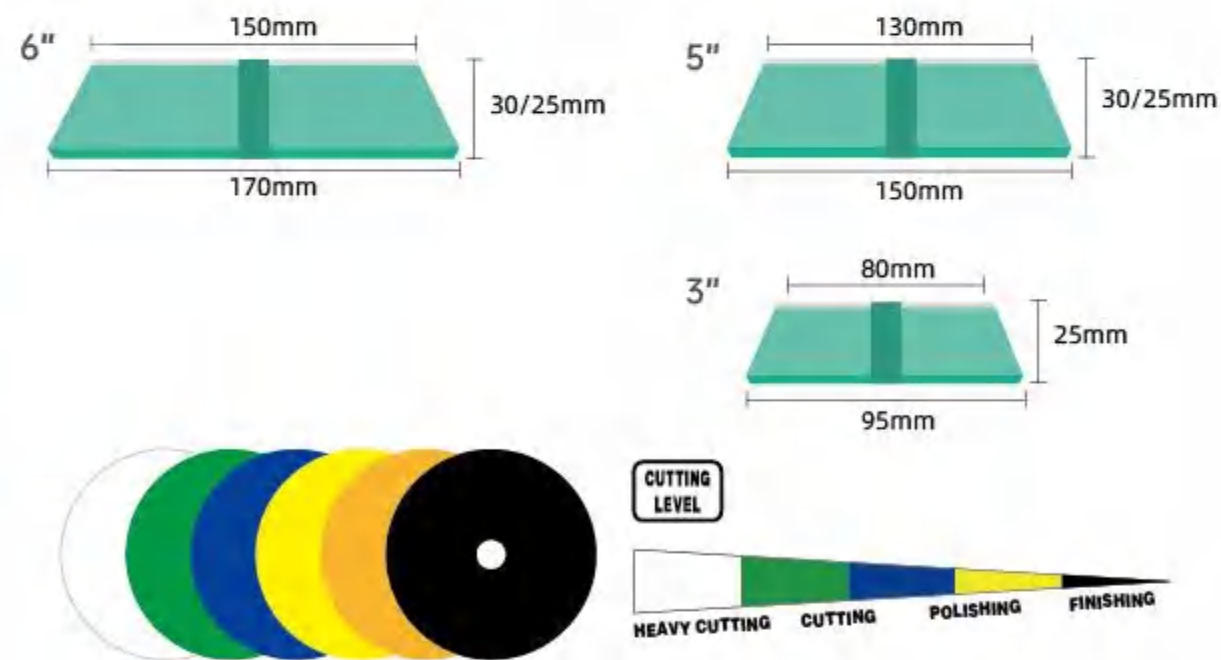

Heavy Cutting	Grey/Green/Blue
Cutting	Dark Red/Yellow/White/Green/Blue
Polishing	Orange/Yellow/White/Green
Finishing	Green/Blue/White/Red/Black

ITEM NO.	SIZE
G3-80	3" 80-95X25mm
G5-130	5" 130-150X30/25mm
G6-150	6" 150-170X30/25mm

**I** SERIES

**Diamond Foam Pad**

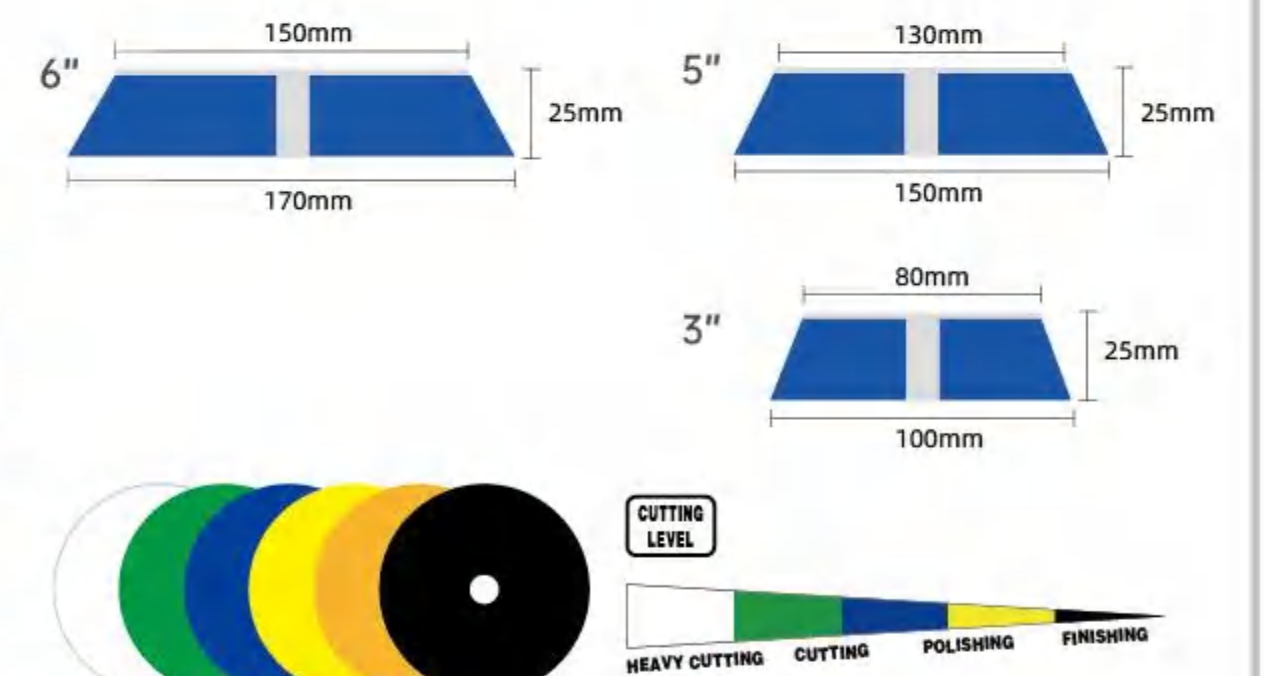

Heavy Cutting	Green/Blue/Grey
Cutting	Red/Yellow
Polishing	Green/Blue/Yellow/Red
Finishing	Green/Blue/Red

ITEM NO.	SIZE
I3-80	3" Ø 80x25mm
I5-130	5" Ø 130x25mm
I6-150	6" Ø 150x25mm

**J** SERIES

**EVA Double Color Foam Polishing Pad For DA**

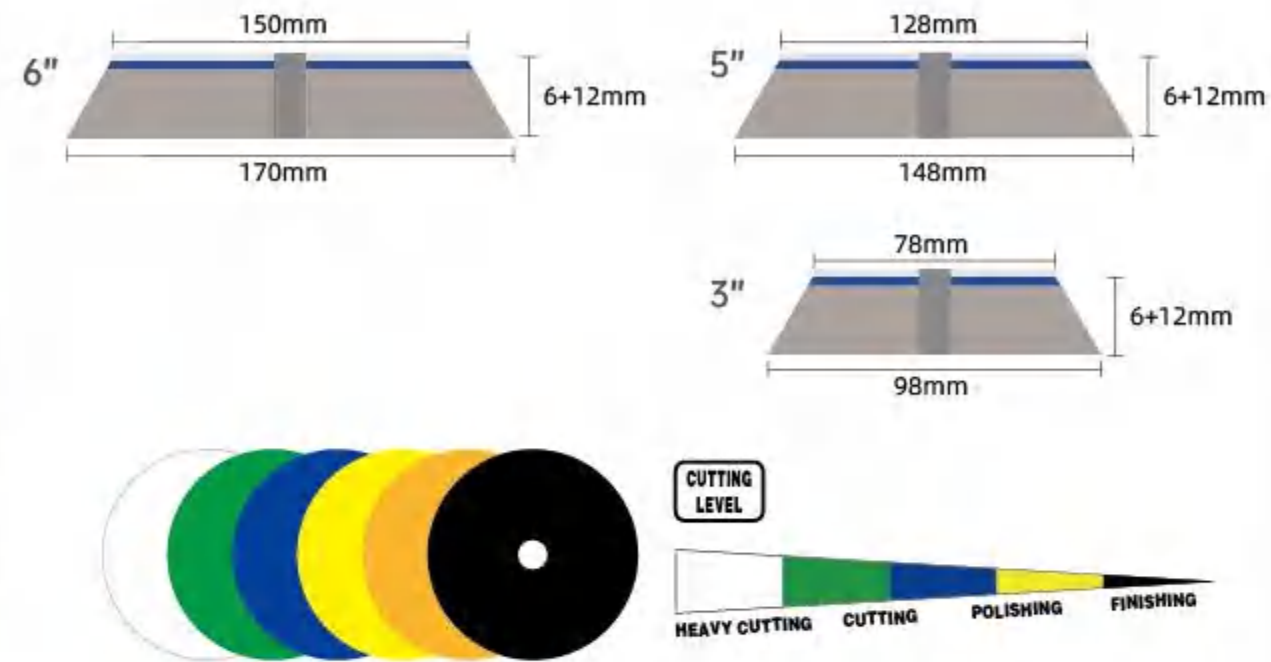

<b>Heavy Cutting</b>	Green
<b>Cutting</b>	Orange/Green
<b>Polishing</b>	Green/Yellow/White
<b>Finishing</b>	Green/Black/White/Red

ITEM NO.	SIZE
J3-78	3" Ø 78x6+12mm
J5-128	5" Ø 128x6+12mm
J6-150	6" Ø 150x6+12mm

**S** SERIES

**Foam Polishing Pad-Flat Face**

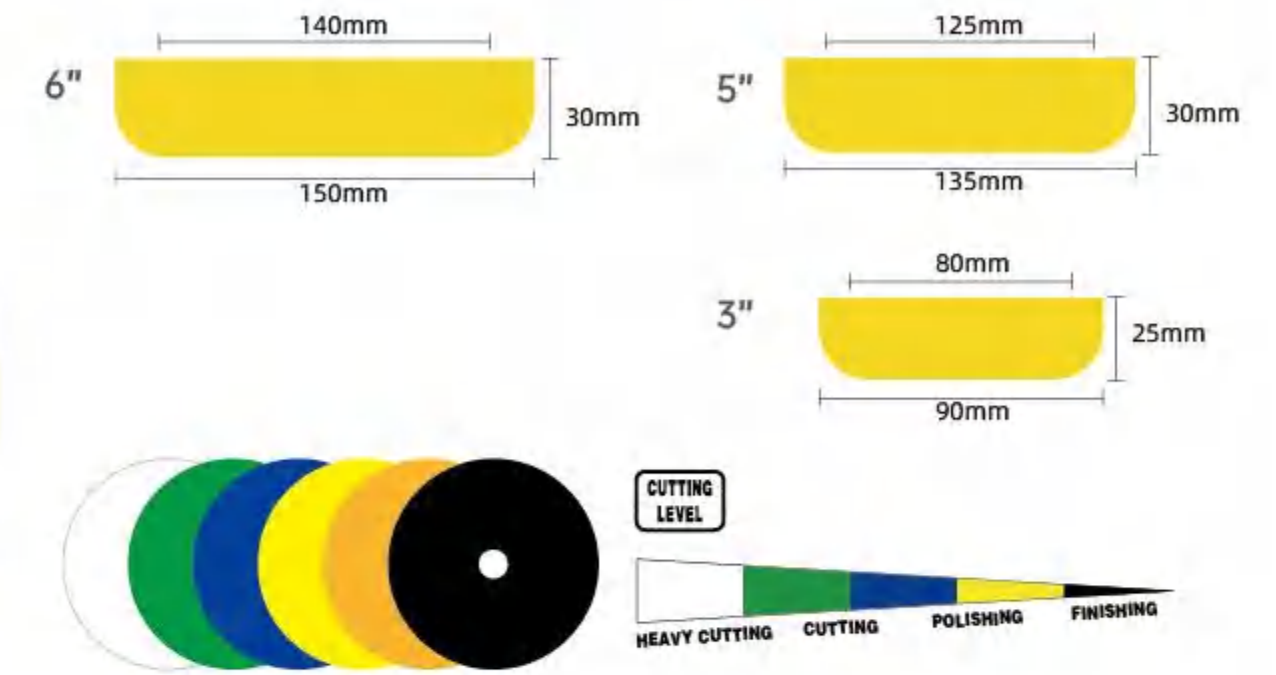

<b>Heavy Cutting</b>	Green/Blue
<b>Cutting</b>	Red/Yellow
<b>Polishing</b>	Green/Blue/Red/White/Yellow
<b>Finishing</b>	Green/Blue/White/Red

ITEM NO.	SIZE
S3-80	3" Ø 80x25mm
S5-125	5" Ø 125x30mm
S6-140	6" Ø 140x30mm

**K** SERIES

**High density Hex-logic Polishing Pad**

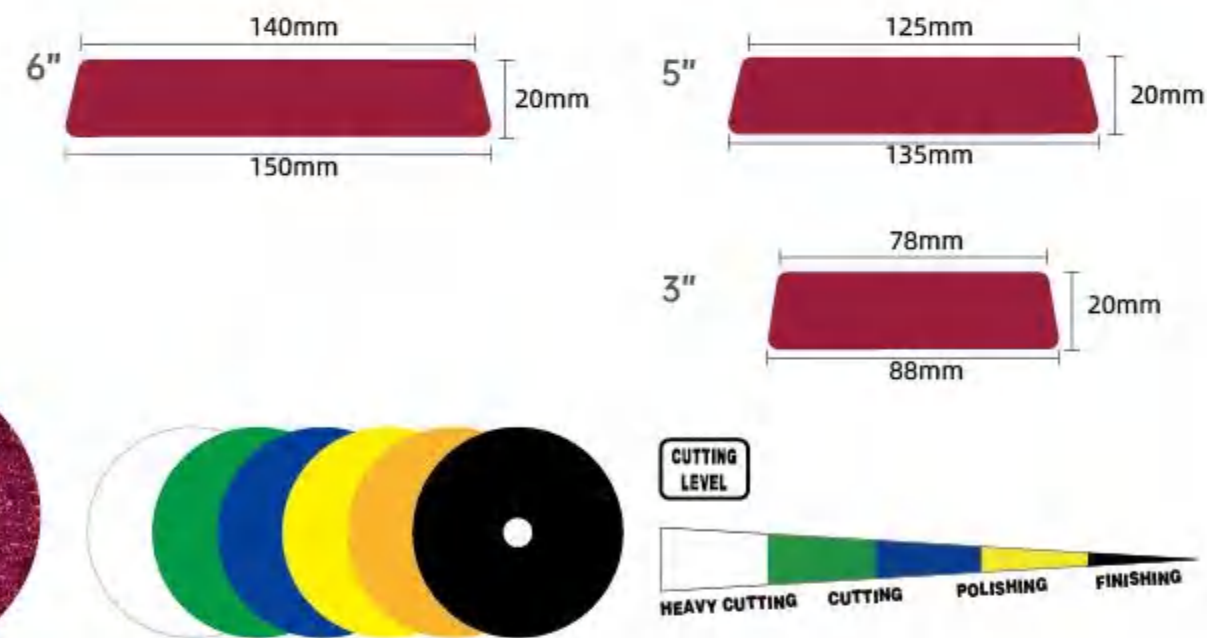

<b>Heavy Cutting</b>	Grey/Green/Blue
<b>Cutting</b>	Drak Red/Orange/Blue
<b>Polishing</b>	Green/Blue/Drak Red/White
<b>Finishing</b>	Green/Blue/White

ITEM NO.	SIZE
K3-78	3" 78X20mm
K5-125	5" 125X20mm
K6-140	6" 140X20mm



**FOAM POLISHING**  
ITEM NO. MS-FPC80  
Ø 80mm  
Mounting: 6mm Shaft



**Interface Pads**

ITEM NO. MS-IP1506" Ø 150x10mm  
ITEM NO. MS-IP1255" Ø 125x10mm  
ITEM NO. MS-IP75 3" Ø 75x10mm / 75x6mm  
ITEM NO. MS-IP50 2" Ø 50x10mm / 50x6mm  
Options: With holes or not



**Orange Peel Removed Pad**

ITEM NO. MS-OPP2000-80A Ø 80x8mm  
ITEM NO. MS-OPP2000-100A Ø 100x8mm  
ITEM NO. MS-OPP2000-135A Ø 135x8mm  
ITEM NO. MS-OPP2000-160A Ø 160x8mm  
Denim

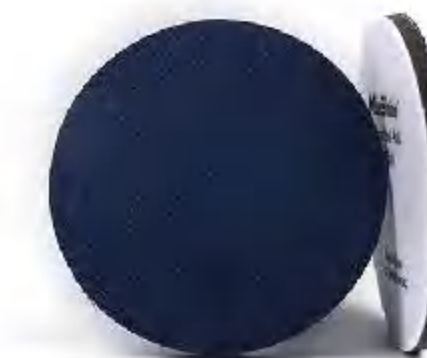

**Orange Peel Removed Pad**

ITEM NO. MS-OPP3000-80A Ø 80x8mm  
ITEM NO. MS-OPP3000-100A Ø 100x8mm  
ITEM NO. MS-OPP3000-135A Ø 135x8mm  
ITEM NO. MS-OPP3000-160A Ø 160x8mm  
Velvet

# PREMIUM MICROFIBER DA PAD





**MD SERIES** Heavy Cutting Microfiber DA Pad





ITEM NO.	SIZE
MD3-85	3" 85-100x(6+8)mm
MD5-125	5" 125-145x(6+8)mm
MD6-150	6" 150-170x(6+8)mm

**MC SERIES** Checkered Microfiber DA Pad



ITEM NO.	SIZE
MC3-80	3" 80x8mm
MC5-130	5" 130x8mm
MC6-140/MC6-150/MC6-160	6" 140/150/160x8mm

**ME SERIES** Microfiber DA Pad

ITEM NO.	SIZE
ME3-80	3" 80x13mm
ME5-130	5" 130x13mm
ME6-155	6" 155x13mm

# WOOL POLISHING PAD

Knitted wool pads offered by Maxshine are of 100% wool content, the customized manufacturing technics produces the material in consistent fiber thickness, nap-height and density, less linting, ensure the pad in uniform quality, unlike the variances that can occur with some natural sheepskin pads

Premium performance on abrasive action and heat-resistance. Working with high-cut wax to aggressively remove scratches and oxid, reduces the swirls and leaves a gloss finish.

Style Options: 1.Bevel Edge(Popular) 2.Straight Edge



**WA** SERIES

**Mixed Foam Wool Polishing Pad**



ITEM NO.	SIZE
WA3-78	3" 78-90X8mm
WA5-130	5" 130-146X10mm
WA6-150	6" 150-165X10mm

Material: 1200gsm wool  
Wool Length: 12mm  
Customized size is available.



**WC** SERIES

**Pro Wool Polishing Pad-Fine Pile Grade**



ITEM NO.	SIZE
WC3-76	3" 76-90X(6+8)mm
WC5-125	5" 125-145X(6+8)mm
WC6-150	6" 150-170X(6+8)mm

Material:  
100% wool+foam+EVA+Velcro  
Customized size is available.



**WB** SERIES

**High-Nap Foam Wool Polishing Pad**



ITEM NO.	SIZE
WB3-80	3" 80X6mm
WB5-130	5" 130X6mm
WB6-150	6" 150X6mm

Material:  
100% Pure wool+foam+Velcro  
Wool Length: 20mm  
Customized size is available.



**WD** SERIES

**High Nap Heavy-Cut Wool Pad**



ITEM NO.	SIZE
WD3-78	3" 78-90X(6+6)mm
WD5-125	5" 125-140X(6+6)mm
WD6-150	6" 150-165X(6+6)mm

Material:  
100% wool+foam+EVA+Velcro  
Wool Length: 6mm  
Customized size is available.

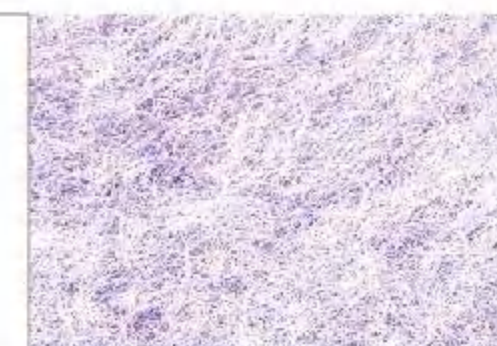

**WE** SERIES**High Nap Wool Pad For DA&RO Polishers**

ITEM NO.	SIZE
WE3-78	3" 78-90X(6+6)mm
WE5-125	5" 125-140X(6+6)mm
WE6-150	6" 150-165X(6+6)mm

Material:  
100% wool+foam+EVA+Velcro  
Wool Length: 6mm  
Customized size is available.

**WG** SERIES**Wool Buffing Polishing Pads**

ITEM NO.	SIZE
WG3-80	3" 80mm
WG5-130	5" 130mm
WG6-150	6" 150mm

Material: wool  
Customized size is available.

**WF** SERIES**Premium Wool Cutting Pad**

ITEM NO.	SIZE
WF3-80	3" 80mm
WF5-125	5" 125mm
WF6-150	6" 150mm

Material: natural wool  
Customized size is available.

**WH** SERIES**100% Natural Lace-up Wool Polishing Pad**

ITEM NO.	SIZE
WH5-130	3" 130mm
WH6-150	6" 150mm
WH7-178	7" 178mm
WH8-203	8" 203mm
WH9-229	9" 229mm

Material: 100% natural wool  
Customized size is available.



**100% Wool Compound Pad**

**Single Sided**



ITEM NO.	SIZE
WI7S-178	7" 178mm

Material: 4 PLY 100% Twisted Wool / 100% Wool

**Note:**  
Wool material allows quick removal of unwanted imperfections  
Recessed cup edge minimizes backing plate contact with surface



**Double Sided**



ITEM NO.	SIZE
WI9D-229	9" 229mm

Material: 4 PLY 100% Twisted Wool / 100% Wool

**Note:**  
Wool material allows quick removal of unwanted imperfections  
Double-sided compound pad designed with unique flexing action



(EU)

Female

M14

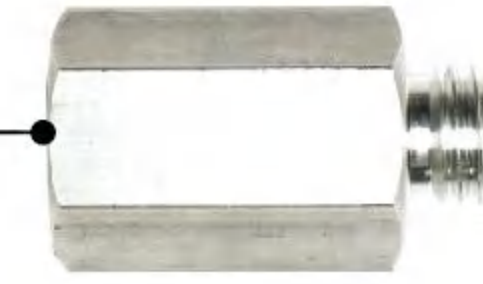

Male

M14

(US)

Female

5/8"



Male

M14



**Premium High-Nap Wool Polishing Pad**



ITEM NO.	SIZE
WL5-130	5" 130x10mm
WL6-155	6" 155x10mm

Wool Length: 20mm  
Material:  
100% Pure wool+foam+Velcro  
Customized size is available.



**WM** SERIES**Premium Wool Polishing Pad**

ITEM NO.	SIZE
WM3-80	3" 80x12mm
WM5-125	5" 125x22mm
WM6-150	6" 150x22mm

Material: wool  
Customized size is available.

**WO** SERIES**Knitting Wool Polishing Pads**

ITEM NO.	SIZE
WO3-80	3" 80x6mm
WO5-125	5" 125x6mm
WO6-150	6" 150x6mm

Material: wool  
Customized size is available.

**WN** SERIES**Heavy-Cut Wool Pad Short-Nap Striped**

ITEM NO.	SIZE
WN3-80	3" 80x12mm
WN5-125	5" 125x22mm
WN6-150	6" 150x22mm

Material: wool  
Customized size is available.

**WP** SERIES**Purple Foamed Wool Pad**

ITEM NO.	SIZE
WP3-80	3" 80x10mm
WP5-130	5" 130x10mm
WP6-155	6" 155x10mm

Material: wool  
Customized size is available.

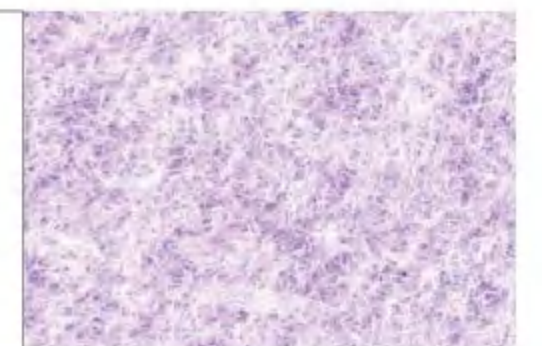

**WQ** SERIES

**Synthetic Wool Cutting Pad**



ITEM NO.	SIZE
WQ3-78	3" 78-90x10mm
WQ5-130	5" 130-146x12mm
WQ6-150	6" 150-165x12mm

Material: wool  
Customized size is available.



**WR** SERIES

**Mixed Air Cool Wool Polishing Pad**



ITEM NO.	SIZE
WR3-80	3" 80x4mm
WR5-130	5" 130x4mm
WR6-155	6" 155x4mm

Material: 100% Wool  
Customized size is available.  
Air Cool elastic fiber material  
Good dust absorption and heat  
dissipation effect.  
Mesh air cool elastic fiber has  
good air permeability.



**WS** SERIES

**Purple Foam Wool Polishing Pad**



ITEM NO.	SIZE
WS3-80	3" 80x6mm
WS5-130	5" 130x6mm
WS6-155	6" 155x6mm

Material: 100% Wool  
Customized size is available.



**WT** SERIES

**Premium Air Wool Cut and Polish Pad**



ITEM NO.	SIZE
WT3-80	3" 80x4 mm
WT5-130	5" 130x4mm
WT6-150	6" 150x4mm

Material: wool  
Customized size is available.



# DETAILING BRUSH



Maxshine Detailing Brushes are an essential tool for any detailer. We have kinds of different purpose detailing brush for options. Whether it's for cleaning wheels, trims, engine bays or fabrics detailing brushes are used in every part of the detail to keep your vehicle looking pristine.



### Curved Grip XL Detailing Brush

ITEM NO. MS- WB60 Series

Size: 3.3in x 5.9in(including holder)

Color: Red & Black

Handle Material: PP & PTE

Package Includes:

1pc Ultra-Soft Bristle, 1pc Mixed Boar's Bristle Brush, 1pc Holder

### Curved Grip XL Detailing Brush Ultra Soft

ITEM NO. MS- WB60-1

Diameter: 2.52 inches

Handle Length: 3.09 inches

Hair Length: 2.36 inches(60mm)

Color: Grey & Black

Handle Material: PP & PTE

Hair Material: Ultra Soft Bristle

Package Includes:

1pc Ultra Soft Bristle Brush, 1pc Holder



### Curved Grip XL Detailing Brush Mixed Bristle

ITEM NO. MS- WB60-2

Diameter: 2.52 in

Handle Length: 3.09 in

Hair Length: 1.97 in(50mm)

Color: Red & Black

Handle Material: PP & PTE

Hair Material: 20% black Boar's Hair & 80% PET

Package Includes:

1pc Mixed Bristle Brush, 1pc Holder





**Natural Boar's Hair  
Detailing Stubby Brush**

**ITEM NO. MS-WB64**  
 Handle Length: 127mm  
 Plastic Circle Dia.: 37mm  
 Bristle Length: 50mm  
 Material: 100% Natural Boar Hair Bristles



**Mixed Bristle  
Detailing Stubby Brush**

**ITEM NO. MS-WB63**  
 Handle Length: 127mm  
 Plastic Circle Dia.: 37mm  
 Bristle Length: 50mm  
 Material: 20% Boar's Hair & 80% PET



**Ultra-Soft Detailing Brush**

**ITEM NO. MS-WB70**  
 Handle Length: 127mm  
 Plastic Circle Dia.: 52mm  
 Bristle Length: 50mm  
 Material: PBT



**Flat Detailing Brush**

**ITEM NO. MS-WB77S**  
 Handle Length: 147mm  
 Handle Width: 29mm

**ITEM NO. MS-WB77M**  
 Handle Length: 174mm  
 Handle Width: 49mm  
 Material: 30% Black Boar Hair + 70% Black PP



### Synthetic Bristles Detailing Brush-Wood Handle

- ITEM NO. MS-WB01-25 (4#) Hair Length:42mm Ø 25mm, 1"
- ITEM NO. MS-WB01-30 (6#) Hair Length:42mm Ø 30mm, 1.2"
- ITEM NO. MS-WB01-35 (8#) Hair Length:48mm Ø 35mm, 1.4"
- ITEM NO. MS-WB01-40 (10#) Hair Length:48mm Ø 40mm, 1.6"

20% Natural Bristle & 80% PP Bristles , Wood Handle



### Synthetic Bristles Detailing Brush-Plastic Handle

- ITEM NO. MS-WB02-8# Ring Dia 17.5mm Handle Length:127mm
- ITEM NO. MS-WB02-10# Ring Dia 21.5mm Handle Length:135mm
- ITEM NO. MS-WB02-12# Ring Dia 24.5mm Handle Length:145mm
- ITEM NO. MS-WB02-14# Ring Dia 27.5mm Handle Length:147mm
- ITEM NO. MS-WB02-16# Ring Dia 31.5mm Handle Length:150mm
- ITEM NO. MS-WB02-18# Ring Dia 35.5mm Handle Length:154mm
- ITEM NO. MS-WB02-20# Ring Dia 38mm Handle Length:160mm

20% Natural Bristle & 80% PP Bristles , Plastic Handle



### 100%PET Bristles Detailing Brush-Wood Handle

- ITEM NO. MS-WB19-2# Ring Dia 15mm Handle Length:55mm
- ITEM NO. MS-WB19-4# Ring Dia 25mm Handle Length:67mm
- ITEM NO. MS-WB19-6# Ring Dia 30mm Handle Length:68mm
- ITEM NO. MS-WB19-8# Ring Dia 35mm Handle Length:70mm
- ITEM NO. MS-WB19-10# Ring Dia 40mm Handle Length:65mm

100% PET Bristles , Wood Handle



### Detailing Brush - White Classic

ITEM NO. MS-M01S-10# Bristle Length:42mm Ø 16mm  
 ITEM NO. MS-M01M-12# Bristle Length:46mm Ø 21mm  
 ITEM NO. MS-M01L-14# Bristle Length:46mm Ø 24mm  
 Bristle Material: White PET  
 Handle Material: Rubber+Plastic Lacquered

Ergonomically designed non-slip handle for a comfortable grip.  
 Easy to use and safe on all surfaces. Perfect for narrow or tight spaces.  
 Great for both interiors and exteriors.  
 Soft and gentle bristles, densely packed for best cleaning performance.  
 Constructed with premium PET bristles.

### Detailing Brush - Black Classic

ITEM NO. MS-M02S-10# Bristle Length:42mm Ø 16mm  
 ITEM NO. MS-M02M-12# Bristle Length:46mm Ø 21mm  
 ITEM NO. MS-M02L-14# Bristle Length:46mm Ø 24mm  
 Bristle Material: 20% Black Bristle+80% Black PET  
 Handle Material: Rubber+Plastic Lacquered

Anti-slip and comfortable grip.  
 Strong yet soft, densely packed bristles for deep cleaning.  
 Perfect for both interior and exterior detailing.  
 Works well dry, or wet with your favorite cleaning solution.

### Detailing Brush - Boar's Hair

ITEM NO. MS-M03S-10# Bristle Length:42mm Ø 16mm  
 ITEM NO. MS-M03M-12# Bristle Length:46mm Ø 21mm  
 ITEM NO. MS-M03L-14# Bristle Length:46mm Ø 24mm  
 Bristle Material: Natural Brown Bristle  
 Handle Material: Rubber+Plastic Lacquered

Anti-slip and ergonomic grip.  
 Perfect for both interior and exterior detailing.  
 Brush head is densely packed, allowing for optimum cleaning.  
 Upgraded boar's hair. Soft, gentle, and durable

### Detailing Brush - Ultra Soft

ITEM NO. MS-M04S-10# Bristle Length:42mm Ø 16mm  
 ITEM NO. MS-M04M-12# Bristle Length:46mm Ø 21mm  
 ITEM NO. MS-M04L-14# Bristle Length:46mm Ø 24mm  
 Bristle Material: Ultra-Soft Synthetic Bristles  
 Handle Material: Rubber+Plastic Lacquered

Non-Slip Rubber Handle with comfortable grip.  
 Constructed of anti-static materials.  
 Ultra-Soft Synthetic Bristles  
 Perfect for delicate surfaces that need a gentle touch.



### Detailing Brush - Classic Boar's Hair 100%

**ITEM NO. MS-M05S**

Bristle Dia.: 22mm Bristle Length: 44mm Handle Length: 123.6mm

**ITEM NO. MS-M05L**

Bristle Dia.: 26mm Bristle Length: 48mm Handle Length: 189.6mm

Material: Natural Brown Bristle



### Detailing Brush - Classic Boar'S Hair Mixed

**ITEM NO. MS-M06S**

Bristle Dia.: 22mm Bristle Length: 44mm Handle Length: 123.6mm

**ITEM NO. MS-M06L**

Bristle Dia.: 26mm Bristle Length: 48mm Handle Length: 189.6mm

Material: 20% Black Bristle + 80% Black PP



### Detailing Brush-Premium Soft

**ITEM NO. MS-M07S**

Bristle Dia.: 22mm Bristle Length: 44mm Handle Length: 123.6mm

**ITEM NO. MS-M07L**

Bristle Dia.: 26mm Bristle Length: 48mm Handle Length: 189.6mm

Material: Nylon Electrostatic Bristle



### Leather and Alcantara Cleaning Brush

**ITEM NO. MS-WB13**

Size: 120x40x10mm Hair Length: 20mm

Material: Wooden Handle+ Soft Bristle



### Horsehair Cleaning Brush-Small

**ITEM NO. MS-WB20**

Size: 120x40x10mm Hair Length: 20mm

Material: Wooden Handle+ 100% Horsehair



### Horsehair Cleaning Brush-Large

**ITEM NO. MS-WB21**

Size: 170x55mm Hair Length: 30mm

Material: Wooden Handle+ 100% Horsehair



### Soft Leather Brush

**ITEM NO. MS-WB07**

Size: 170x60mm Hair Length: 30mm

Material: Wooden Handle +Soft PP/Nylon/Horse Bristle



### Ergonomically Leather Brush

**ITEM NO. MS-WB08**

Size: 150x65mm Hair Length: 30mm

Material: Horse Hair



### Nano Fabric/Leather Cleaning Brush

**ITEM NO. MS-WB50**

Length: 12cm Width: 5.5cm

Height: 3.5cm

Material: Nano Felt

# Car Detailing Brush



**ITEM NO. MS-WB03**

8# ∅ Length 160mm 16# ∅ Length 280mm  
 10# ∅ Length 180mm 18# ∅ Length 320mm  
 12# ∅ Length 220mm 20# ∅ Length 350mm  
 14# ∅ Length 260mm  
 Hair Length: 45mm  
 Material: PP Handle, 100% Boar's Hair bristles



**ITEM NO. MS-WB25**

Handle Length: 205mm Hair Length: 55mm  
 Material: PP+ rubberized grip,  
 black PBT hard bristle



**Lambswool Detailing Duster**

**ITEM NO. MS-DD01**  
 Wool Part: 25cm  
 Handle Length: 60cm



1

**ITEM NO. MS-WB37**

Handle Length: 220mm Hair Length: 45mm  
 Material: PP+Nylon 612, Electrostatic wool



2

**ITEM NO. MS-WB38**

Handle Length: 220mm Hair Length: 45mm  
 Material: PP Handle, 100% Boar's Hair bristles



**ITEM NO. MS-WB39**

Handle Length: 220mm Hair Length: 45mm  
 Material: PP Handle, 100% sharpening fiber



3

2

1

**WB37-KIT Series** Handle Length: 220mm Hair Length: 45mm

**ITEM NO. MS-WB37**

Material: PP+Nylon 612, Electrostatic wool

**ITEM NO. MS-WB38**

Material: PP Handle, 100% Boar's Hair bristles

**ITEM NO. MS-WB39**

Material: PP Handle, 100% sharpening fiber



**Stiff Bristle Detailing Brush**

**ITEM NO. MS-WB25**

Handle Length: 205mm Hair Length: 55mm  
 Material: PP+ rubberized grip,  
 black PBT hard bristle



**ITEM NO. MS-WB62 L**

Handle Length: 20.8cm Bristle Length: 4.8cm  
 Material: PP Handle+Rubber

**ITEM NO. MS-WB62 S**

Handle Length: 13.2cm Bristle Length: 4.6cm  
 Material: PBT Bristles



**ITEM NO. MS-WB59**

Size Details: 7.4cm x 3.2cm x 6.3cm  
 Material: Nylon, Plastic



**Engine Brush**

**ITEM NO. MS-EB01**

Handle Length: 280mm Hair Length: 40mm  
 Material: Plastic Handle+ boar hair / PP  
 The bristles can be customized, PP and boar hair.



**Ultra Soft Detailing Circle Brush**

**ITEM NO. MS-WB55 Series**

Dia.: 5.2cm Height: 6cm Hair Length: 1.8cm  
 Material: Nylon

Includes: 1 Brush & 1 Brush Storage Case

**ITEM NO. MS-WB55-Y** Hair Color: Yellow

**ITEM NO. MS-WB55-B** Hair Color: Black



**SOFT GRIP TIRE CLEANING BRUSH**  
**ITEM NO. MS-WB65**  
 Size: 222.48\*60\*12mm  
 Material: Red PP+Black TPE Handle  
 PP Bristles



**SOFT GRIP WHEEL AND BODY BRUSH**  
**ITEM NO. MS-WB68**  
 Size: Size: 270.19\*72\*14.8mm  
 Material: Red PP+Black TPE Handle  
 PET+PBT Bristles



**SOFT GRIP TIRE & WHEEL CLEANING BRUSH  
 LONG HANDLE**  
**ITEM NO. MS-WB69**  
 Size: 523.4\*72\*15mm  
 Material: Red PP+Black TPE Handle  
 PET+PP Bristles



**Leather Cleaning Brush**

**ITEM NO. MS-WB47**  
 Size: L 12.5 x W 5.5cm Hair Material: Horse +PP  
 Hair length: 2.5cm Handle Material: wooden handle

Leather Cleaning Brush is used for gently clean interior, leather seat, vinyl and fabric convertible tops.



**Tire Cleaning Brush**

**ITEM NO. MS-WB48**  
 Size: L 12.5 x W 5.5cm Hair Material: PP  
 Hair length: 2.5cm Handle Material: wooden handle

Designed for use on modern alloy wheels this handy brush enables all parts of the tire to be accessed.



**Heavy-Duty Wheel And  
Carpet Cleaning Brush**

**ITEM NO. MS-WB44**

Size: 8 x 3 x 1in

PVC hair diameter: 40mm

Material: PP handle & PVC hair



**Exterior Surface And  
Wheel Cleaning Brush**

**ITEM NO. MS-WB43**

Size: 8 x 3 x 1in

PVC hair diameter: 25mm

Material: PP handle & PVC hair



**Medium-Duty Wheel  
& Body Brush**

**ITEM NO. MS-WB42**

Size: 8 x 3 x 1in

PVC hair diameter: 25mm

Material: PP handle & PVC hair



**Tire Scrub Brush**

**ITEM NO. MS-WB09**

Size: 210x64mm Hair Length: 25mm

Material: Plastic Handle

Soft PP/ Nylon/ Horse Bristle



**Wheel Brush**

**ITEM NO. MS-WB32**

Length:270mm Material: PP



**Wheel And Engine 360°  
Cleaning Brush**

**ITEM NO. MS-WB31**

Length:280mm Material: PP



**ITEM NO. MS-WB06**  
 Length:170mm  
 Material: PP with PP Fiber



**ITEM NO. MS-WB16**  
 Length: 170mm Hair Length: 10mm  
 Handle Length: 100mm



**ITEM NO. MS-WB50**  
 Length: 12cm Width: 5.5cm  
 Height: 3.5cm  
 Material: Nano Felt



**Car Carpet Brush**  
**ITEM NO. MS-WB11**  
 Length:150mm  
 Material: PP



**TIRE & CARPET CLEANING BRUSH**  
**ITEM NO. MS-WB12**  
 Length:190mm  
 Material: PP handle with PP Fiber

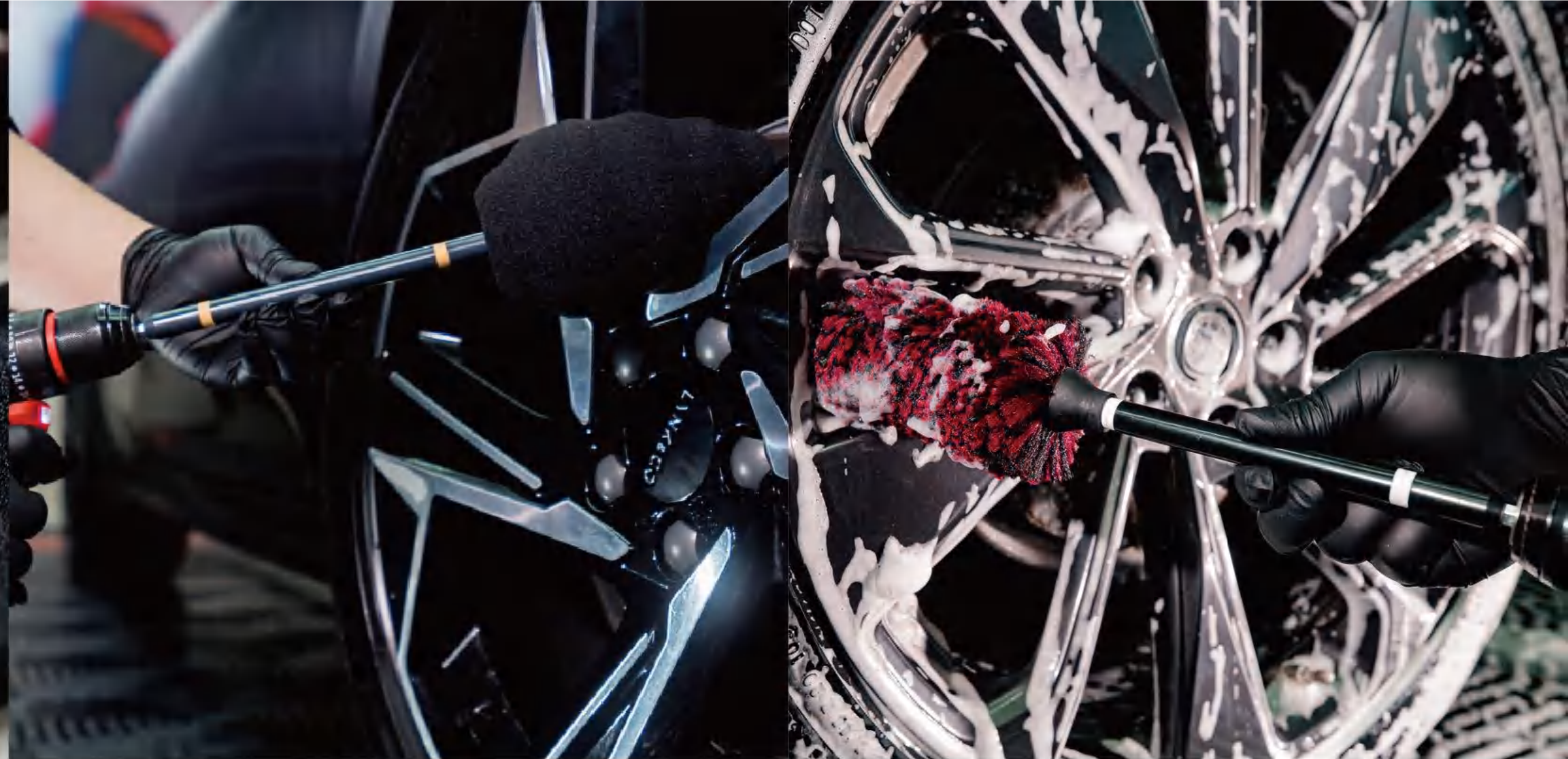

**Drill Carpet Brush**  
**ITEM NO. MS-DAB01**  
 Size: Ø125mm / Ø100mm / Ø50mm



**Carpet Brush**  
**ITEM NO. MS-DAB03**  
 Size: Ø125mm  
 Hair length: 23mm / 40mm



**Duty Drill Wheel Brush**  
**ITEM NO. MS-DTB01**  
 Hair Length: 30mm  
 Handle Length: 30mm  
 Material: Nylon



**Synthetic Wool Drill Power Wheel Brush with Drill Adapter**  
**ITEM NO. MS-WBD01**  
 Total length: 37cm Material: Imitation wool



**PowerFoam Wheel Brush (Drill Powered)**  
**ITEM NO. MS-DTB03**  
 Size: 35cm Hair Length: 15cm  
 Material: Premium Foam



**Premium Synthetic Wool Wheel Brush (Drill Powered)**  
**ITEM NO. MS-DTB02**  
 Size: 34cm Hair Length: 15cm Hair Dia: 7 cm  
 Material: Synthetic Wool



Mini Pet Hair Car Carpet Brush

ITEM NO. MS-WB

Size:10cm

Color:Red ABS+Black Silicone



Mini Pet Hair Car Carpet Brush

ITEM NO. MS-WB57

Size:10cm

Color:Red ABS+Black Silicone



Car Carpet Brush

ITEM NO. MS-WB26

Size:160x50mm Hair Length: 30mm

Material: PP with TPR



Silicone Interior Detailing Brush

ITEM NO. MS-WB49

Size: 29x8cm Material: Silicone



ITEM NO. MS-WB54

Size: 12x4x4cm

Material: Silicone

Color: Accept Customization



Large

Small



### Wheel and Rim Brush

ITEM NO. MS-WB17 450mm

ITEM NO. MS-WB18 300mm

Durable, flexible, and safe to use on all wheel types.  
Easily reaches delicate nooks and crannies. Extremely Flexible.

50cm

45cm

35cm

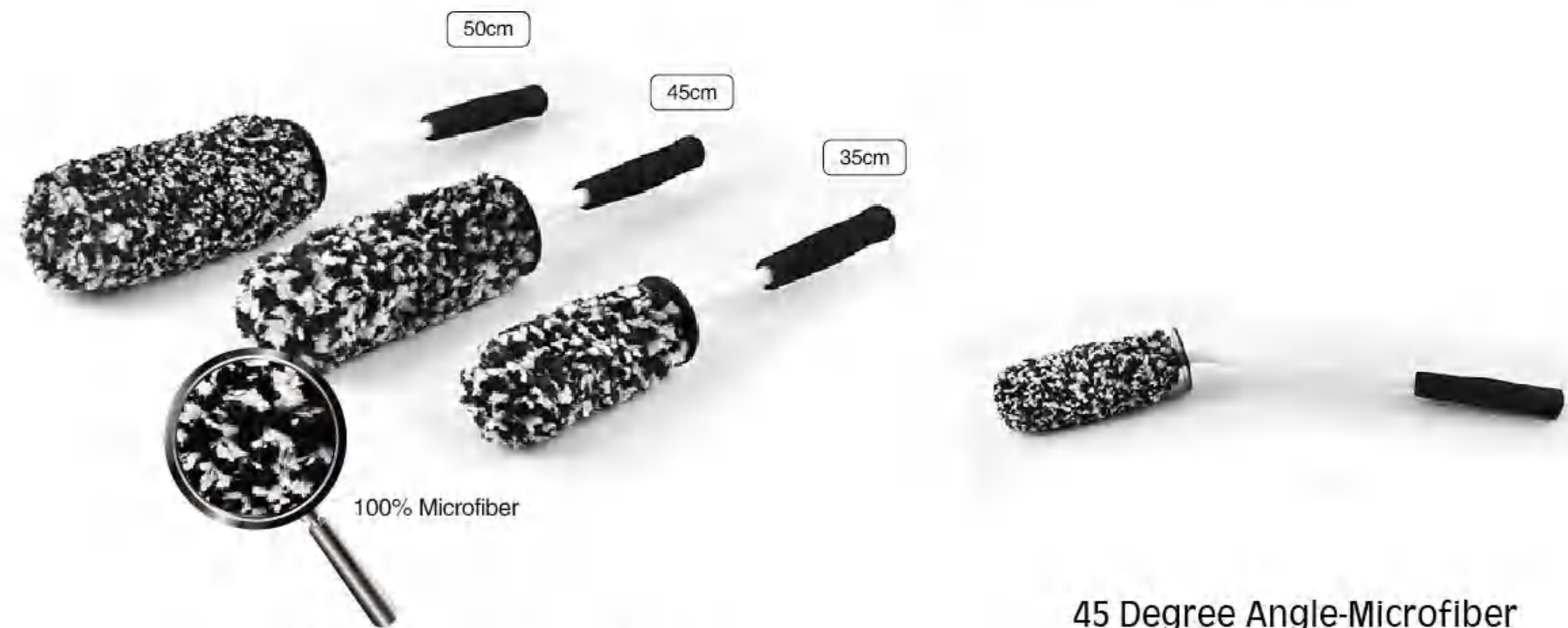

### Microfiber Wheel Brush-3 Pieces Kit

MS-MB-KIT

ITEM NO. MS-MB01 Length:35cm, Microfiber Part Length:15cm, Dia.7cm

ITEM NO. MS-MB02 Length:45cm, Microfiber Part Length:16cm, Dia.9cm

ITEM NO. MS-MB03 Length:50cm, Microfiber Part Length:20cm, Dia.10cm

### 45 Degree Angle-Microfiber Wheel Brush

ITEM NO. MS-MB04  
Length:55cm

Microfiber Part Length:16cm, Dia.7cm



**Premium Flat Microfiber Wheel Brush with Replaceable Cover**

**ITEM NO. MS-MB09 Large**  
 Total Length: 50cm Microfiber Cover Diameter: 5.5cm  
 Microfiber Cover Length: 18.5cm

**ITEM NO. MS-MB09-S Small**  
 Total Length: 36cm Microfiber Cover Diameter: 5.5cm  
 Microfiber Cover Length: 14cm

- Features:
- Removable Brush Head for easy cleaning and replacement.
  - Metal-Free Construction ensures safe, scratch-free wheel cleaning.
  - Heavy-Duty Microfiber Sponge Compresses for greater flexibility.



**ITEM NO. MS-CWB01** Length:31cm  
**ITEM NO. MS-CWB03** Length:39cm  
**ITEM NO. MS-CWB04** Length:42cm  
**ITEM NO. CWB-KIT01**  
 Including: 1pc CWB01 1pc CWB03 1pc CWB04

**ITEM NO. MS-WB45** Length:45cm  
**ITEM NO. MS-WB46** Length:25cm  
 Material: Synthetic Wool Brush



**Ultimate Wool Wheel Brush-3 Pieces Kit**

- ITEM NO. MS-WWB01 Length:35cm
- ITEM NO. MS-WWB02 Length:40cm
- ITEM NO. MS-WWB03 Length:45cm
- ITEM NO. MS-WWB-KIT01

Including 1pc MS-WWB01  
 1pc MS-WWB02 1pc MS-WWB03  
 Much More Aggressive, Fast To Clean Wheel!  
 100% Natural Sheepskin Wool!

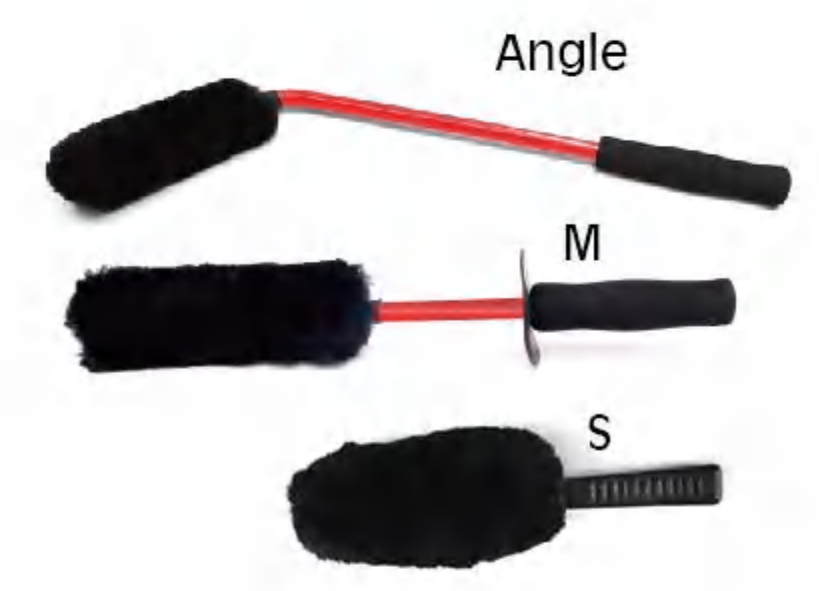
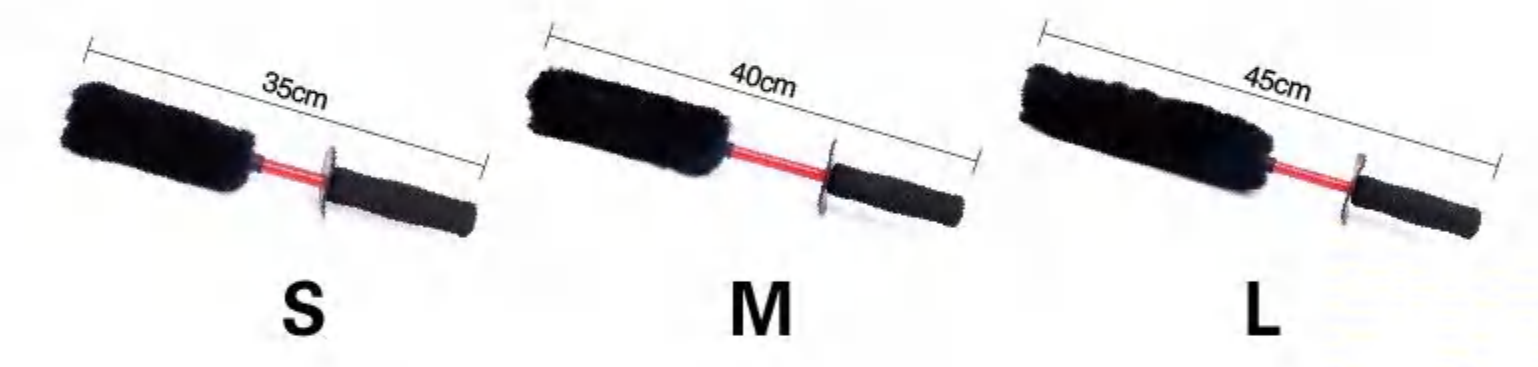

**Ultimate Wool Wheel Brush**

- ITEM NO. MS-WWB02 Length:40cm
- ITEM NO. MS-WWB05 Length:49cm
- ITEM NO. MS-WWB06 Length:25cm
- ITEM NO. MS-WWB-KIT02

Including  
 1pc MS-WWB02  
 1pc MS-WWB05  
 1pc MS-WWB06



# PREMIUM CAR DUSTER



## Car Duster Exterior Scratch Free With Extendable Handle

ITEM NO. MS-WB76  
 Length: 64-88cm ( Scalable )  
 Width: 12cm Bristle Length: 12cm  
 Material: Cotton Bristles+Extendable Handle



## Car Duster Exterior Extendable Handle

ITEM NO. MS-WB75  
 Length: 64-88cm ( Scalable )  
 Width: 12cm Bristle Length: 12cm  
 Material: Microfiber Bristles+Extendable Handle



## Mini Interior Duster

ITEM NO. MS-WB72  
 Handle Length: 23cm  
 Bristle Length: 6cm  
 Dimension and Weight: 35(L) x 8(W) cm, 0.11kg

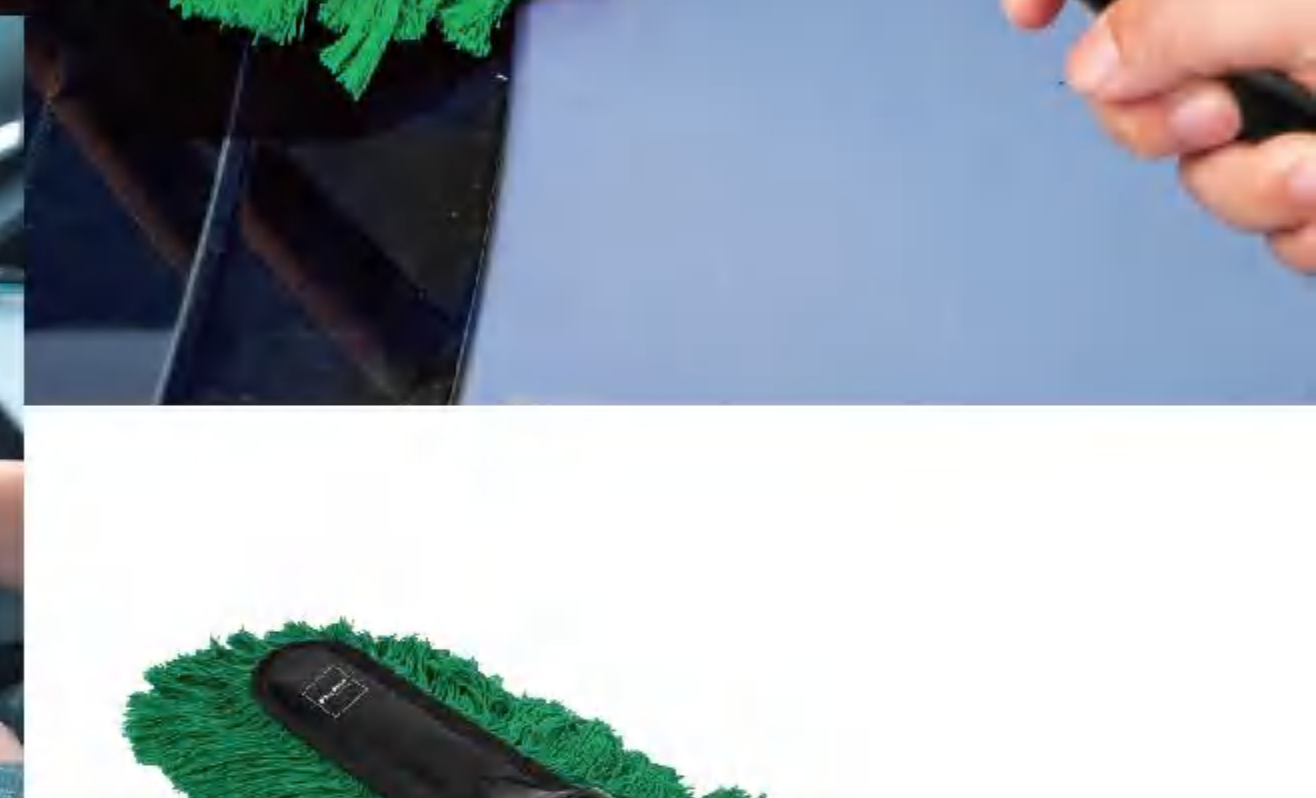

**Car Duster Combo**

ITEM NO. MS-WB74

ITEM NO.	Length	Width	Bristle Length	Handle Length
WB74-Small	33cm	5cm	10cm	12cm
WB74-Large	61cm	8cm	11cm	41cm

Material: Cotton Bristles+ Plastic Handle

**Car Duster Premium Combo Kit  
Wood Handle Classic & Mini Duster**

ITEM NO. MS-WB73

ITEM NO.	Length	Width	Bristle Length	Handle Length
WB73-Small	33cm	5cm	10cm	12cm
WB73-Large	61cm	8cm	11cm	41cm

Material: Cotton Bristles+ Wooden Handle

## X-Large Premium Car Duster

ITEM NO. MS-WB71

Length: 76cm Bristle Length: 10.6cm  
 Handle Length: 43cm Width: 16cm  
 Material: Cotton Bristles+ Wooden Handle



## Car Microfibre Universal Brush Cover

ITEM NO. MS-MBC01

Size: 20x31cm  
 Material: High Quality Microfiber Cotton  
 Application: Flexible PVC Wash Brush Cover



## Car Wash Chenille Brush With Retractable Handle

ITEM NO. MS-FCB01

Size: Pole length from 23.2" extend to 43.3" (55-110cm)  
 Handle Material: Aluminum Alloy Pipe Walls  
 Brush Cover Material: Chenille (Customized)  
 Brush Cover Size: 7.09" x 11.02" (18x28cm)



## FLEXIBLE PVC WASH BRUSH

ITEM NO. MS-PWB01

Pole length 1.2m, extends to 2.4m  
 Material: Aluminum+PVC  
 Designed for cars, trucks, SUVs, RVs, All the floors, walls and Ceilings



## Premium Detailing Extension Microfiber IncrediStick

ITEM NO. MS-FCB02 Series

Pole length: 63cm Pole Length Extended: 120cm Length with Mitt Head: 138cm  
 Mitt Head Dimensions: 26x13cm Plate Size: 23 x 11.4cm Pole and Plate Material: High Strength Aluminum  
 Package includes: 1pc extendable incrediStick, 1pc grey chenille headcover, 1pc red and white microfiber headcover



FCB02-HRW  
Microfiber & Thin Sponge



FCB02-HBK  
Scrub Fabric & Sponge



FCB02-HG  
Chenille & Thin Sponge



FCB02-HBL  
Soft Plush Microfiber  
& Sponge



FCB02-HY  
Mesh Sponge



## SOFT BRISTLE BRUSH HEAD



**ITEM NO. MS-BH-BS**  
 Bristle Material: PET & PBT  
 Base Material: Beechwood  
 6.7 x 3.1in/17 x 8cm



**ITEM NO. MS-BH-BL**  
 Bristle Material: PET & PBT  
 Base Material: Beechwood  
 9.8 x 3.1in/25 x 8cm

## STIFF BRISTLE BRUSH HEAD



**ITEM NO. MS-BH-WS**  
 Bristle Material: PBT  
 Base Material: Beechwood  
 6.7 x 3.1in/17 x 8cm



**ITEM NO. MS-BH-WL**  
 Bristle Material: PBT  
 Base Material: Beechwood  
 9.8 x 3.1in/25 x 8cm

## MEDIUM BRISTLE BRUSH HEAD



**ITEM NO. MS-BH-YS**  
 Bristle Material: PP  
 Base Material: Beechwood  
 6.7 x 3.1in/17 x 8cm



**ITEM NO. MS-BH-YL**  
 Bristle Material: PP  
 Base Material: Beechwood  
 9.8 x 3.1in/25 x 8cm

## CLASSIC SOFT BRUSH HEAD



**ITEM NO. MS-BH-RS**  
 Bristle Material: PET & PBT  
 Base Material: Beechwood  
 6.7 x 3.1in/17 x 8cm



**ITEM NO. MS-BH-RL**  
 Bristle Material: PET & PBT  
 Base Material: Beechwood  
 9.8 x 3.1in/25 x 8cm

## TELESCOPING HANDLE FOR Cleaning BRUSH

- Telescopic Aluminum Handle: Adjust the 3-section pole to your desired length for flexible cleaning in various situations.
- Ergonomic Comfort Grip: Enjoy a secure and comfortable hold, reducing hand fatigue during extended cleaning sessions.
- Lightweight and Portable: Easily transport and store the handle, making it convenient for on-the-go cleaning tasks.
- Versatile Compatibility: Pair with MaxShine Brush Heads to customize your cleaning for detailed work or large surface areas.
- Extended Reach: Effortlessly clean hard-to-reach areas on boats, RVs, and home exteriors, ensuring a thorough clean every time.

**ITEM NO. MS-TH-6**  
 Extension Length: 4-6ft  
 Material: High Strength Aluminum

**ITEM NO. MS-TH-9**  
 Extension Length: 4-9ft  
 Material: High Strength Aluminum

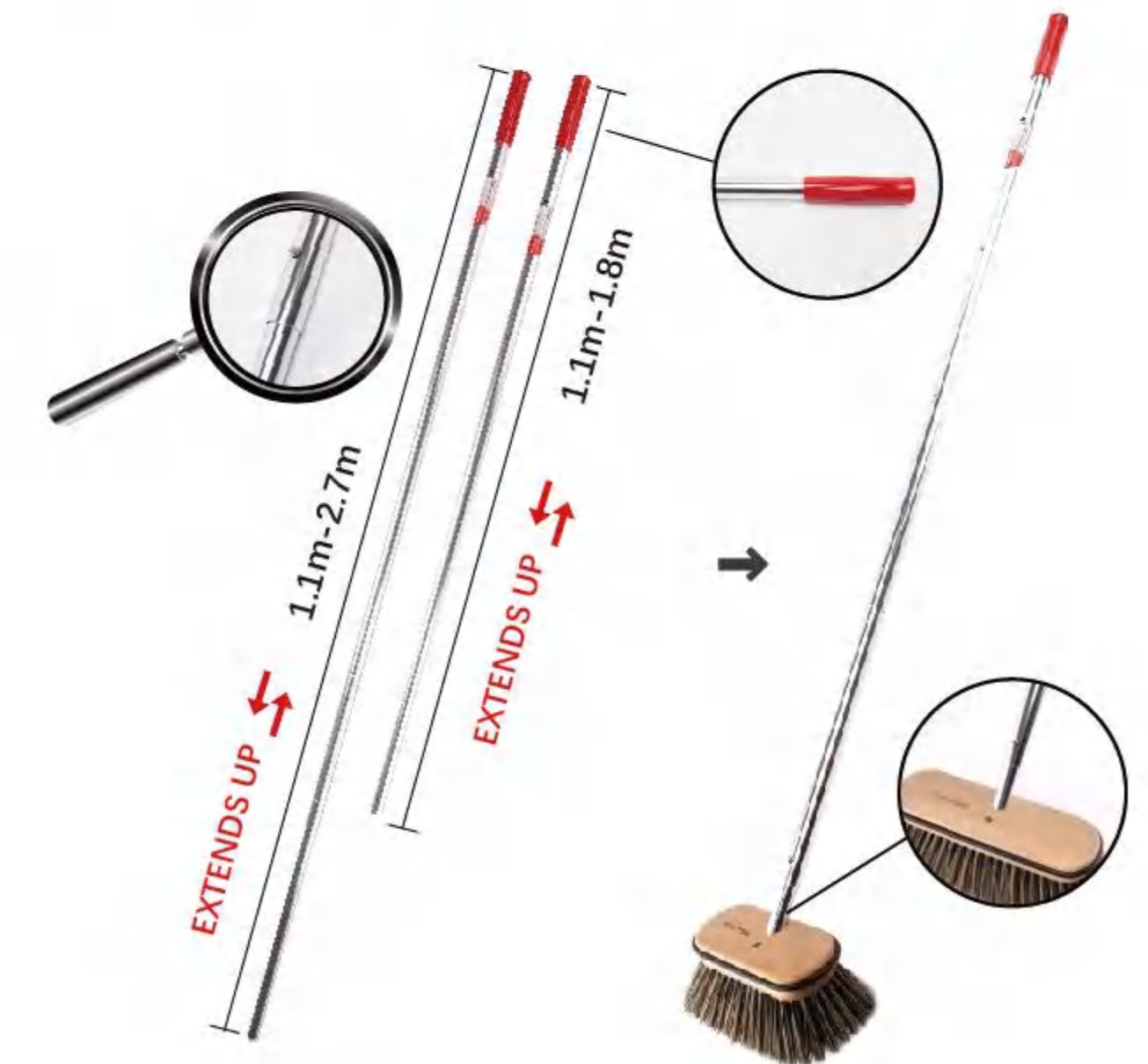

# CLAY PRODUCTS SERIES

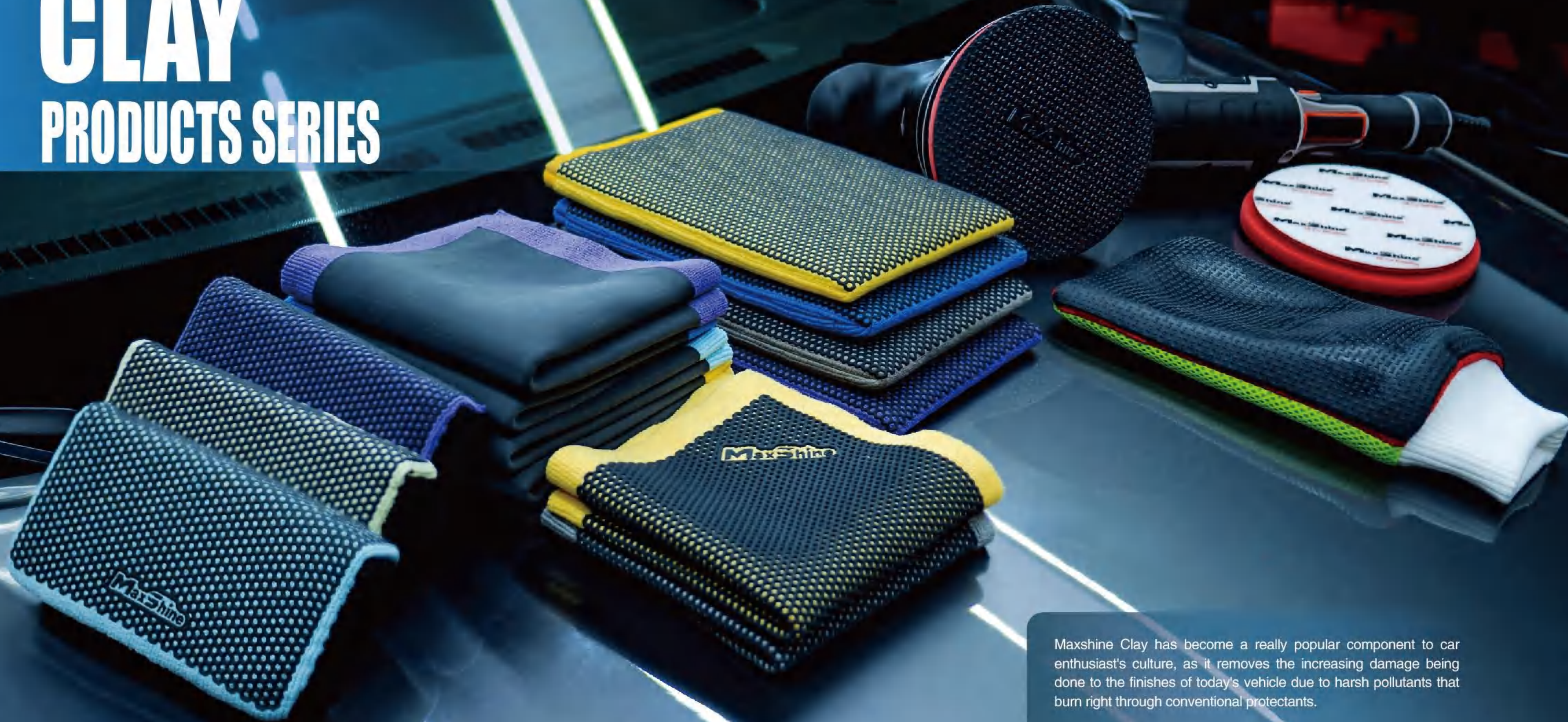

Maxshine Clay has become a really popular component to car enthusiast's culture, as it removes the increasing damage being done to the finishes of today's vehicle due to harsh pollutants that burn right through conventional protectants.



## CLAY TOWEL

- **Customizable hollow-logo:** Place your logo anywhere.
- **Multiple colors & sizes:** Perfect fit for any need.
- **Back customization:** Printed or embossed logos and patterns.
- **Tailored texture pattern :** Unique designs for every towel.
- **Versatile edges & back:** Cut, hemmed, printed or embossed.

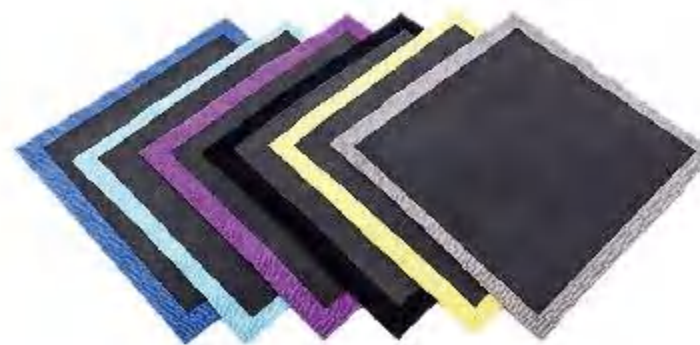

ITEM NO. MS-MCT3030-V4  
Size: 30x32cm(Customized)

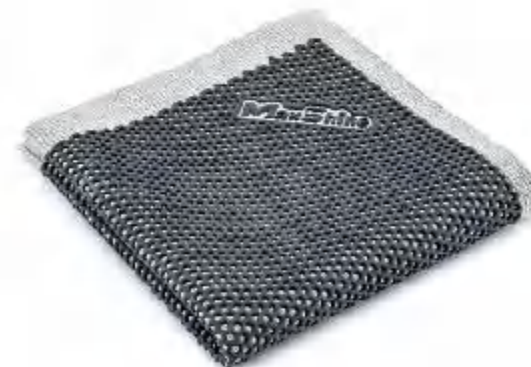

ITEM NO. MS-MCT3030-V3  
Size: 30x32cm(Customized)



ITEM NO. MS-MCT3030-V2  
Size: 30x30cm



ITEM NO. MS-MCT3030  
Size: 30x30cm



## CLAY PAD

- **Customizable hollow-logo:** Place your logo anywhere.
- **Tailored texture pattern:** Unique designs for every clay pad.
- **Back customization:** Printed or embossed logos and patterns.
- **Multiple colors & sizes:** Perfect fit for any need.



ITEM NO. MS-CP80-V4 Ø80x13mm (3")  
ITEM NO. MS-CP125-V4 Ø125x13mm (5")  
ITEM NO. MS-CP150-V4 Ø150x13mm (6")



ITEM NO. MS-CP150 Ø150x13mm (6")  
ITEM NO. MS-CP125 Ø125x13mm (5")  
ITEM NO. MS-CP80 Ø80x13mm (3")



ITEM NO. MS-CP150-V2 Ø150x13mm (6")  
ITEM NO. MS-CP125-V2 Ø125x13mm (5")  
ITEM NO. MS-CP80-V2 Ø80x13mm (3")



## CLAY SPONGE BLOCK

- **Tailored texture pattern :** Unique designs for every sponge.
- **Customizable hollow-logo:** Place your logo anywhere.
- **Multiple colors & sizes:** Perfect fit for any need.
- **Back customization:** Printed or embossed logos and patterns.



**ITEM NO. MS-MCB04**  
Size: 11x7x4cm



**ITEM NO. MS-MCA01**  
Size: 10.5x6cm



**ITEM NO. MS-MCB02**  
Size: 11.2x6.2x3cm



**ITEM NO. MS-MCB03**  
Size: 11x7x4.5cm



## CLAY MITT

**Tailored texture pattern:**

Unique designs for every clay pad.

**Multiple colors & sizes:** Perfect fit for any need.

**Customizable logo:** Provides excellent durability and customizable embroidered logo.

**Back customization:** Custom towel colors, structures & materials for your exclusive mitt combinations.



**ITEM NO. MS-MCM04**  
Size: 26x16cm



**ITEM NO. MS-MCM05**  
Size: 21.6x15.5cm



**ITEM NO. MS-MCM02**  
Size: 30x11-18cm



**ITEM NO. MS-MCM01**  
Size: 22x14cm



**ITEM NO. MS-MCM03**  
Size: 22x14cm



## PREMIUM CLAY SPONGE



ITEM NO. MS-MCB05

Size: 16x9x4cm Material: 80/20 Microfiber+Clay

- Tailored texture pattern:** Unique designs for every sponge.
- Multiple colors & sizes:** Perfect fit for any need.
- Customizable hollow-logo:** Place your logo anywhere.
- Back customization:** Different materials combinations can be sewn together, e.g., long-pile car wash towel+clay surface..



Microfiber Clay Block Wash Pad

ITEM NO. MS-MCB06

Size: 12.6 x 7.28in / 32 x 18.5cm Material: Sponge, Clay, and Microfiber



The microfiber flexible edge allows the clay to comply with all the vehicle's.



## CLAY BAR



- ITEM NO. MS-CB50 50g
- ITEM NO. MS-CB100 100g
- ITEM NO. MS-CB150 150g
- ITEM NO. MS-CB200 200g

## Hand Clay Bar Pad Auto Car Wash Body



ITEM NO. MS-HCP01

Size: 13 cm Material: Clay Type: Paint Cleaner

# SNOW FOAM

# LANCER

Maxshine is professional manufacturer of Snow Foam Lance. we have kinds of different sharp snow foam lance for options. Maxshine Quality design and fittings provide excellent durability for everyday usage. Maximum Pressure 160 Bar. Max Temp 60 Degrees

Maxshine snow foam lance works with a pressure washer to produce a thick, clinging foam.

Give your vehicle a "touch-free" wash with this high powered foam gun.

Complete with your choice of connector.

(Karcher, Alto, Lavor, M22, Bosch and Karcher HDS Fix Fitting...etc)



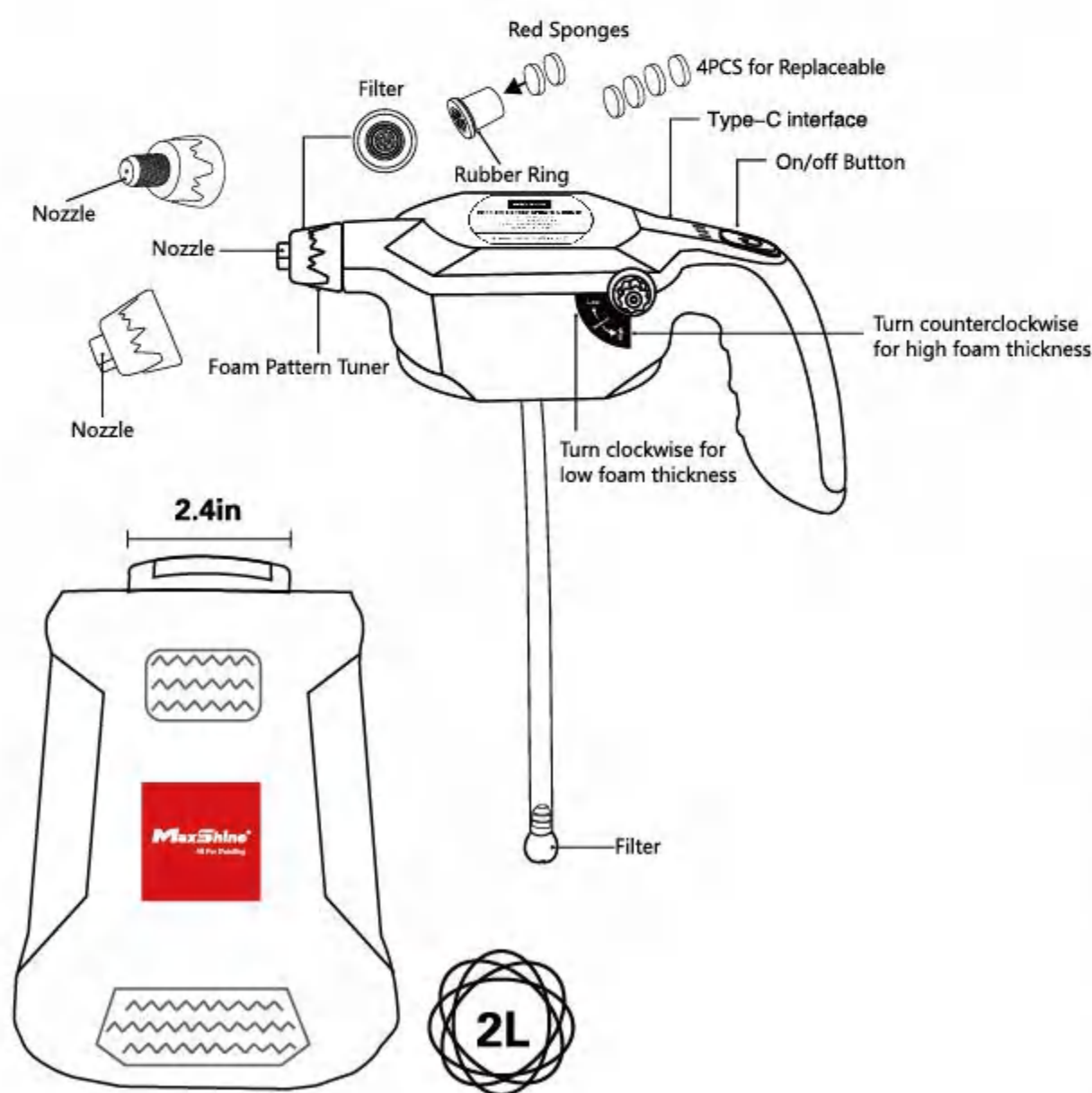

**Cordless Electric Sprayer & Foamer**

**ITEM NO. MS-P05**  
 Size: 27(L) x 13(W) x 26(H)cm, 0.8kg  
 Charger: 5V/800MA(Type -C cable)  
 Li-ion Battery: 7.4Vdc/2600mAh  
 2L(70oz) Reservoir  
 1PC Thin Foam Nozzle & 1PC Thick Foam Nozzle  
 1PC Spray Nozzle



**Snow Master Foam Cannon V2**

**ITEM NO. MS-FL10** Capacity: 1L(35oz) Maximum Pressure: 200BAR / 3000PSI  
 Requires Pressure: 70BAR / 1000PSI  
 Size and Weight: 6.65in (L) x 4.29in (W) x 10.63in (H), 1.52lbs  
 Material: Heavy-duty PET Clear Bottle With Moulded Grip



**Snow Master Foam Gun V2**  
ITEM NO. MS-MFG01

Capacity: 1L(35oz)  
Size and Weight: 15.63in (L) x 4.29in (W) x 9.33in (H), 1.54lbs  
Material: PET + Stainless Steel      Bottle: High Transparent PET



**Short Wand High Pressure Washer Gun**

ITEM NO. MS-HWG01  
Maximum pressure: 5000 PSI  
Nozzles Tips: 3 Pressure Power Washer Nozzles Tips  
Plug: M22 14 Swivel 3/8" Plug



**Snow Master Foam Cannon**

ITEM NO. MS-FL06  
Cup Volume: 35oz(1000ml)    Inlet: 1/4" F  
Minimum Pressure: 870 PSI    Nozzle Diameter: 1-1/4"  
Minimum Flow: 1.3 GPM    Maximum Temperature: 140° F  
Maximum Pressure: 3,190 PSI    Maximum Flow: 5.3GPM

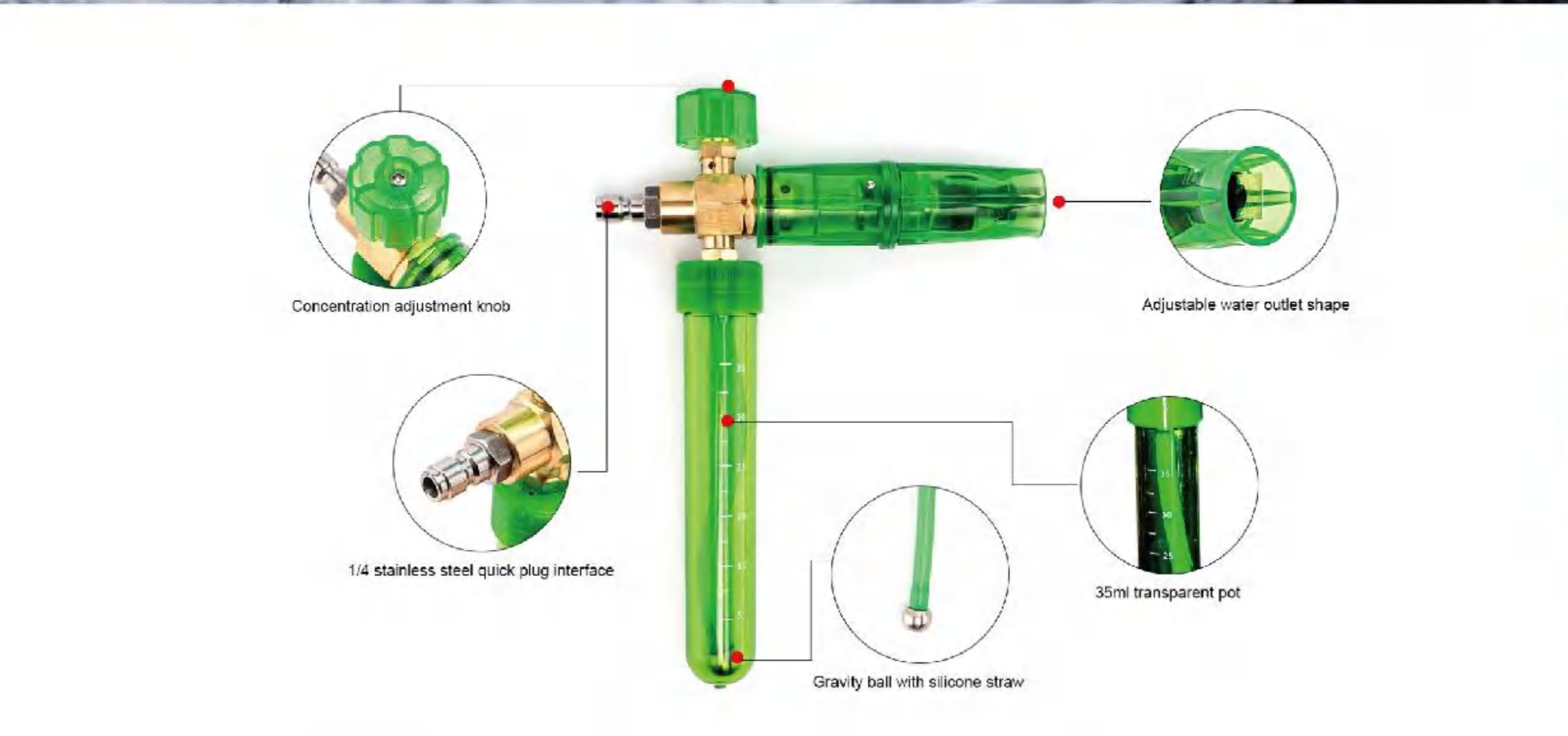

### High Pressure Wash Gun Foam Concentrate Pot

ITEM NO. MS-HFC01

Material: Plastic/Copper+PET bottle  
Green silicone gravity ball straw

Volume: 35ml    Copper orifice size: 1.25  
Comes with 1/4" quick-connect plug

### Snow Foam Cannon

ITEM NO. MS-FL02

Material: PP with copper connector  
Cup Volume: 1 L  
Complete with your choice of connectors,  
such as Karcher K,Alto,Bosch,Lavor,M22,Karcher HD.etc.

### Foam Wash Gun

ITEM NO. MS-FWG01

Material: PP, ABS Body  
with copper connector  
Cup Volume: 1 L  
Water Pressure: 40-90PSI  
Ratio: 5 ratio settings to suit your needs

### Snow Foam Lance

ITEM NO. MS-FL01

Material: PP with copper connector  
Cup Volume: 1 L





### 1L Transparent Snow Master Foam Cannon

**ITEM NO. MS-FL05**

Material: PP with copper connector

Cup Volume: 1 L

Adjustable Spray Pattern with 360-degree Adjustment.

Suitable for a wide range of Pressure Washer Units on the Market.



### New Pressure Washer Nozzles

**ITEM NO. PWN01**

Hole Diameter: 1.2mm ( 040)

Material: Plastic + Stainless

Color: Red, Yellow, Green, White

Working pressure: 100 bar–200bar(1450psi–3000psi) Max temp 60 Celsius

Package Content:

4 x Tip ( 1 x Red Tip (0 Degree)+1 x Yellow Tip (15 Degree)+1 x Green Tip (25 Degree)+1 x White Tip (40 Degree)



### Foam Cannon High Performance Foam Sprayer For Car Detailing

**ITEM NO. MS-FL09**

Material: PE.HD with copper Cup Volume: 1000 ML Color: Black



2 grooves on the two side for easy opening of the foam cannon cap



### Premium Stainless Steel Spray Nozzle Set

**ITEM NO. PSN01**

Orifice Size: 1.0 Material: Stainless Steel

Connection: ¼-inch Quick Release Fitting

Dimensions and Weight: 4.5 x 4.5 x 7.3 cm, 0.08kg(1pc)





### Foam & Wash 2-In-1 System

**ITEM NO. FWS01**

Size: 26.5 (L) x 2.3(W) x 8.7 (H) cm, 0.34kg

Max Pressure: 5000psi

Max Temperature: 60°

Connection: 1 / 4 Inch Quick Connect

Material: Stainless-Steel



### 1.5L Manual Pressure Sprayer

**ITEM NO. MS-P04**

Material: PP with copper connector

Cup Volume: 1.5 L

Hand-held pump sprayer used for car care, home and industrial cleaning.

Suitable for foam spray



### Handheld 1.5L Pressure Sprayer

**ITEM NO. FL08-1 / ITEM NO. FL08-2**

Sprayer Type: Handheld

Capacity: 1.5L (50oz)

Max Working Pressure: 3 Bar (43.5 PSI)

2 Styles For Customers to Choose(Bottle)

Package Including:

Pressure Sprayer+Foam Sprinkler+Chemical Spray Nozzle+Shim



**TORNADOR  
CLEANING  
GUN**



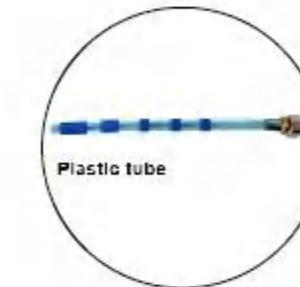

**ITEM NO. MS-TCG01**  
 Size: 24\*32cm  
 Air Pressure: 0.4 to 0.8 MPa  
 Air Flow Rate: 260 L/min at 0.5 MPa  
 Cup Volume: 1 L



**ITEM NO. MS-TCG02**  
 Size: 23\*35cm  
 Air Pressure: 0.4 to 0.8 MPa  
 Air Flow Rate: 260 L/min at 0.5 MPa  
 Cup Volume: 1 L



**ITEM NO. MS-TCG03**  
 Size: 25\*41cm  
 Air Pressure: 0.4 to 0.8 MPa  
 Air Flow Rate: 260 L/min at 0.5 MPa  
 Cup Volume: 1 L



### Multi-function Tornador

ITEM NO. MS-MT01

Size: 16x34cm

Air Pressure: 0.4 to 0.8 MPa

Air Flow Rate: 160 L/min at 0.5 MPa



### Water Cannon Multifunction Spray Gun 8 Settings Built In Soap Dispenser

ITEM NO. MS-WCG01

Size: 43x15x5cm

Material: ABS Plastic

Garden Water Gun Type: Sprayer



### Tornador Mini Air Powered Cleaning Tool

ITEM NO. MS-DR04

Size: 20.5x4.5x4cm

Air Consumption: 226.56 L/m

Air Inlet: 1/4"

Air Pressure: 90 PSI (6.3 bar)

Weight: 0.15 kg



### Drying Tornador

ITEM NO. MS-DT01

Size: 18x30cm

Air Pressure: 0.4 to 0.8 MPa

Air Flow Rate: 160 L/min at 0.5 MPa



### Dirt Remover

ITEM NO. MS-DR01

Size: 20x27cm

Air Pressure: 0.4 to 0.8 MPa

Air Flow Rate: 160 L/min at 0.5 MPa



### Engine Tornador

ITEM NO. MS-ET01

Size: 16x53cm

Air Pressure: 0.4 to 0.8 MPa

Air Flow Rate: 160 L/min at 0.5 MPa



**Car Tornado Dust Blower Cleaning Gun**

ITEM NO. MS-DR03

Size: 20x3x15cm Product Weight: 0.26kgs

Air Consumption: 120L-160L/min

Pressure: 7bar

Material: Steel

Air outlet connect: EU, US or Japanese



**Tornado Car Cleaning Gun Air Blow Dust**

ITEM NO. MS-TCG04

Size: 30x5x23cm Product Weight: 0.46kgs

Free Rotation Speed: 6000RPM

Air Consumption: 120L-160L/min Pressure: 7bar

Liquid Consumption: 3L-3.7L/hr

Air outlet connect: EU, US or Japanese



**High Pressure Air Pulse Car Cleaning Gun**

ITEM NO. MS-TCG05

Size: 69x13x23cm

Product Weight: 0.9kgs

Air Consumption: 120L-160L/min

Liquid Consumption: 3L-4L/hr Pressure: 7bar

Air outlet connect: EU, US or Japanese



**Clean Interior & Exterior Surfaces With Tornado Air**

ITEM NO. MS-TCG06

Size: 32x13x23cm Product Weight: 0.7kgs

Free Rotation Speed: 8000RPM

Air Consumption: 120L-160L/min Pressure: 7bar

Liquid Consumption: 3L-3.7L/hr

Air outlet connect: EU, US or Japanese



**High Pressure Car Interior Spraying Washing Gun With 2 Set Nozzle**

ITEM NO. MS-DR02

Product Weight: 0.4kgs

Free Rotation Speed: 8000RPM

Air Consumption: 120L-160L/min

Pressure: 7bar

Air outlet connect: EU, US or Japanese

# DETAILING SPRAYER



Heavy Duty Chemical Resistant Trigger Sprayer

ITEM NO. MS-FL07

Capacity: 750ml / 25oz

Trigger: Made in Taiwan,China.

Bottle: Made in China.

Color: Customizable



Heavy -Duty Trigger Sprayer

ITEM NO. MS-TG01

Material: PP and Copper

Total capacity: 700ml



Heavy -Duty Trigger Sprayer

ITEM NO. MS-TSN01

Fits 32oz bottles you can cut the dip tube  
to fit 24oz and 16oz bottle

Dip Tube Length 19cm

Closure:28/410



# DETAILING TOOL BAG

Carry your DA/RO polishers, pads, and polishes, microfiber cloths, waxes from the garage to the car club or concours event in this Maxshine Detailing tool Bag. The Maxshine Detailing tool bag is built with detailers in mind, It has a place for everything! Store your DA Polishers, buffing pads, swirl removers, waxes, and brushes. ...etc Compartmentalized storage space keeps everything organized and easy to find.



Detailing Tool Bag -600D Oxford Fabric

ITEM NO. MS-DB4

Size: 45x25x30cm

Material:600D

Quality Stripes for Fasten the machine





### Detailing Tote Bag -1680D Oxford Fabric

ITEM NO. MS-DB10

Size: 32x21x25cm

Material: Polyester fiber





---

ITEM NO. MS-DB7  
 Size: 24x19x22cm  
 Material:1680D



---

ITEM NO. MS-DB8  
 Size: 29x24x24cm  
 Material:1680D



---

ITEM NO. MS-DB9  
 Size: 50x26x22cm  
 Material:1680D



---

ITEM NO. MS-DB11  
 Size: 25x20x23cm  
 Material:Polyester fiber



---

ITEM NO. MS-DB12  
 Size: 35x27x29cm  
 Material:Polyester fiber



**Quick Load Detailing Caddy & Storage Organizer Bag**

ITEM NO. MS-DB1

Size: 49x25.5x30cm (no cover)

Material:600D



**Quick Load Detailing Caddy Bag with Cover**

ITEM NO. MS-DB1-C

Size: 49x25.5x30cm (with cover)

Material:600D



**Detailers Bag with Storage Organizer**

ITEM NO. MS-DB3

Size: 42.5x24x34cm

Material:600D



**DETAILING BELT**

ITEM NO. MS-DBT01

Including 5 small pockets ,1 belt

Flexible Combination

Perfect for detailing

# FOAM WAXING APPLICATOR

Maxshine offer kinds of different material waxing applicators. Maxshine innovative combination of materials causes wax, polish, interior and exterior dressings, and sealants to spread more evenly, resulting in maximum coverage while using less product. super soft and perfect cleaning ability, more durable and environmentally friendly, only work with water and without chemical, easy cleaning for car.



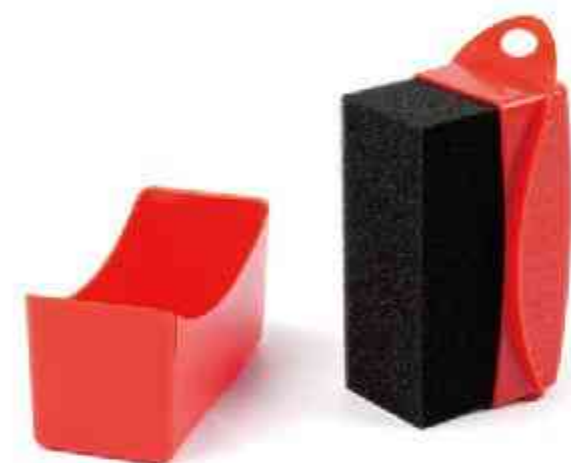

### Dressing & Protectant Applicator

ITEM NO. MS-FA-4B

Size: 12x5.5x7cm

Colour: Black / Blue / Red / Yellow / Gray

Color can be customized

Material: Sponge / PP



### Tire Dressing Applicator With Cover

ITEM NO. MS-FA-41

Size: 3.56 in x 4.79 in Material: ABS+Sponge



### Tire Foam Applicator

ITEM NO. MS-FA-19

Size: 8.3x9.5x(2.5+3.5)cm

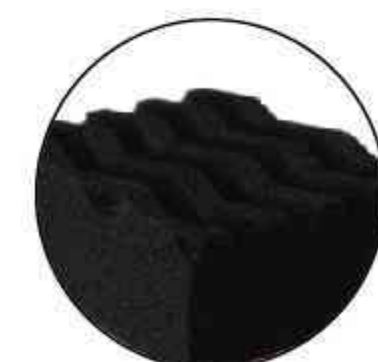
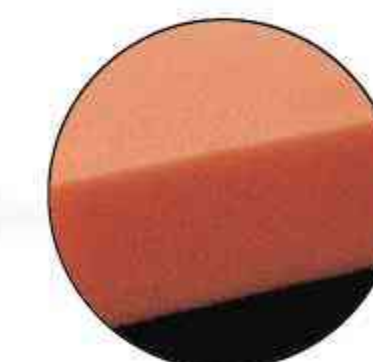



ITEM NO. MS-FA-4 Size: 10x4x(2.5+3.5)cm



ITEM NO. MS-FA-35 Size: Ø 10x1.5cm



ITEM NO. MS-FA-22 Size: 10x5.5x4cm



ITEM NO. MS-FA-23 Ø 11x4.5cm



ITEM NO. MS-FA-15  
Size: 15.5x9.2x(1.2+1.2+1.2)cm



ITEM NO. MS-FA-34 Size: 9.5x4x(3+3.5)cm

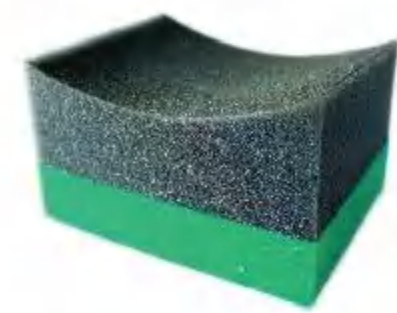

ITEM NO. MS-FA-33 Size: 10x8x(2+4)cm



ITEM NO. MS-FA-14  
Size: 15.5x10x(1+2)cm



ITEM NO. MS-FA-31  
Size: 16x8x3.5cm



ITEM NO. MS-FA-32  
Size: Ø10.5x6cm(large) Ø6.5x6cm(small)



ITEM NO. MS-FA-11  
Size: 7.4x(1.2+1.5)cm



ITEM NO. MS-FA-37 Size: 8.5x4x4cm



Tapered Foam Applicator  
ITEM NO. MS-FA-12  $\varnothing$  10x2.5cm



ITEM NO. MS-FA-1  $\varnothing$  10.5x2cm



ITEM NO. MS-FA-2  $\varnothing$  10.5x2cm



Finger Foam Applicator  
ITEM NO. MS-FA-3 Size: 12x8cm



ITEM NO. MS-FA-40 Size: 6.6x3.7x(3+3)cm  
Colour: Blue/Gray



ITEM NO. MS-FA-38  
Size: 13.5x9.5x4.5cm



Coating Applicator  
ITEM NO. MS-FA-5 Size: 10x4.6x(1.5+5)cm



Plush Microfiber Applicator  
ITEM NO. MS-FA-7 Ø13x2cm



Terry Microfiber Applicator  
ITEM NO. MS-FA-6 Ø13x2cm



ITEM NO. MS-FA-20 Ø13.5x2.5cm



ITEM NO. MS-FA-21  
Size: 12x15.5x5cm



ITEM NO. MS-FA-25  
Size: 16x10x4.5cm



ITEM NO. MS-FA-27  
Size: 15x10cm



ITEM NO. MS-FA-36  
Ø85x10 mm



ITEM NO. MS-WAX-A  
Ø72mm PU Block  
Ø75mm Orange/Blue/Yellow Applicator  
Ø75mm Black/White Applicator



ITEM NO. MS-FA-39  
Size: 12x8.5cm  
Material: Microfiber+Sponge



# DETAILING ACCESSORIES

Make things easy by yourself and get the right tools!  
You've already spent enough on your waxes and polishes, you might as well get the right accessories to properly clean and protect your car. We have sourced the finest range of accessories that compliment the entire car cleaning process.





**Heavy Duty Ultra Clear Detailing Bucket**

ITEM NO. MS-PB03 Transparent  
 Volume:3.5 Gallon,Outside Dia.300mm,Height:280mm  
 Volume:5 Gallon,Outside Dia.300mm,Height:385mm



**Bucket Caddy**

ITEM NO. MS-BB01  
 Size: 34x15x22.2mm Material: PP  
 Brush slots: 14mm & 18mm  
 Color: Black & Red



**Work Gloves Breathable**

ITEM NO. MS-WGB01  
 Item Dimensions: S/M/L/XL/XXL  
 Material: Polyester / Carbon Fiber / Nitrile Scrub



**Sand Killer With Washboard Insert**

**ITEM NO. MS-GG02**  
 Size: 26.4 (L) x 26.4(W) x 5.3(H) cm  
 Weight: 0.51kg Material: PP&Fiberglass  
 Fits most 3.5-5 gallon buckets

**Pad Cleaning Tools**

**ITEM NO. MS-PSR**  
 Perfect For Cleaning Wool/Foam Pads  
 Buffing Polishing Pad Cleaning Tools  
 Buffing&Polishing Pad ,Wool Polishing Pad Cleaning Spur



**Folding Wash Bucket**

**ITEM NO. MS-FWB01**  
 Volume: 2-20L Material: 600D  
**ITEM NO. MS-PB02**  
 3.5 Gallon or 5 Gallon



**Cross Bucket Lid**

**ITEM NO. MS-CBL01**  
 Volume: 20L Size: Ø305mm Material: PP  
 Volume: 13L Size: Ø300mm Material: PP





**Multifunction Bucket Lid Seat with Soft Foam**

**ITEM NO. MS-MBL01**

Dimension: 35.2x31.2x3.5cm

Material: Hard plastic & Sponge

Color: Black & Red



**Detailing Kneeling Pad**

**ITEM NO. MS-KP01**

Material: EVA Foam    Size: 18" x11" x1.6"





**Silicone Soft Water Blade  
With Anti-Slip Handle-3 Layer Lips**

**ITEM NO. MS-SWB04**  
Length: 11" x 3.2"  
Material: 100% Silicone And Rubber



**Ezy Wheel Hose Slide Rollers**

**ITEM NO. MS-EZW01**  
Color: Red  
Material: Plastic



# MODULAR DETAILING CREEPER

## New Creeper II with Soft Cushion

ITEM NO. MS-NC02

Dimensions: 95cm x 40cm x 36cm (with additional bottle holders)

Holds: 6 bottles (4-22oz max) with additional holders attached



## New Creeper II

ITEM NO. MS-NC01



Modular Detailing Creeper  
Bottle holder, set of 2

ITEM NO. MS-NC01



Mini Creeper

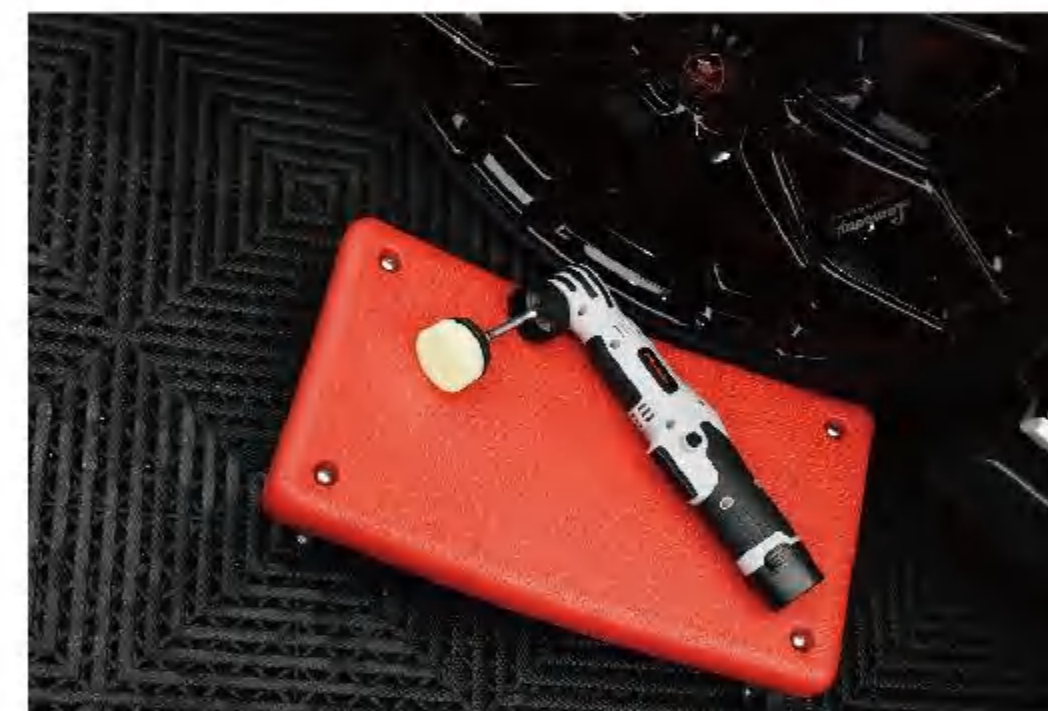

ITEM NO. MS-MC01

Dimensions: 47 x 26 x 11cm

Material: PPT30



ITEM NO. MS-SRC01

Dimensions: 48 x 28 x 6cm

Material: Soft rubber polyether



## Premium Detailing Rolling Chair

ITEM NO. MS-DRC04

Height: Adjustable 17.72" to 25.59"

Weight Capacity: 400 lbs Color: Black / Red

Cushion Size: 14.17" x 4.72"

Casters: 4" Industrial Casters with 2 Brakes

Material: Iron, Stainless Steel, Leather, and Sponge



Optional Iron Tool Tray to keep tools close at hand

Tool Tray: (Sold Separately)

22.83" x 22.83" x 0.94"

Material: Iron



ITEM NO. MS-DRC01

Material: Steel+PU+Sponge

Min. Height: 415mm

Max. Height: 550mm



ITEM NO. DRC02

Material: Steel+PU+PP

Size: 73cmx63cm



**Folding Detailing Cart**



**New Premium Steel Detailing Rolling Trolley II**



**ITEM NO. MS-DRL06**  
 Material: PP & Steel  
 Size: 74cm(H) x 66cm(L) x 40cm(W)  
 The fold length is 16cm.



**ITEM NO. MS-DRL05**  
 Material: High Quality Steel    Size: 97.9x50.3x90.35cm

- Three 16oz (Dia:70mm) and three 32oz (Dia:89mm) bottle holders
- Two Curved Grip XL Brush holders (Dia:62mm).
- One Snow Master Foam Cannon V2 holder (Dia:122mm)
- Two small chemical holder (Dia:43mm)
- Four detailing brush holders (Dia:20–31mm)
- Two polisher & one mini polisher holders
- 4" Swivel Rubber Wheels, Dual Locking, Dual Bearing, 360 Degree Rotation



# Premium Heavy Duty Detailing Cart

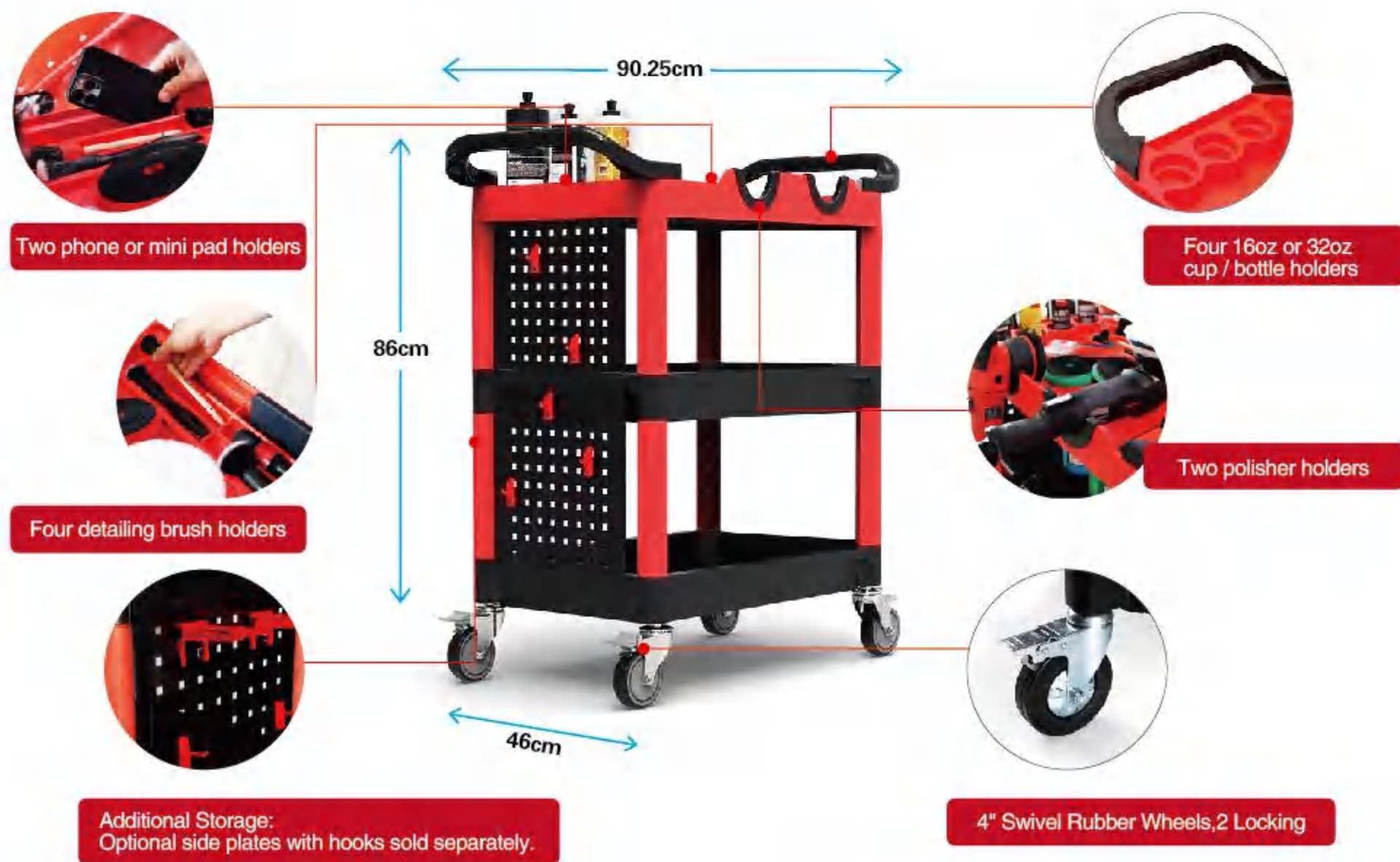

ITEM NO. MS-DRL04 Material: PP Color: Red+Black Size: 90.25x46x86cm



ITEM NO. MS-DRL02  
Material: PP  
Overall Dimensions: 97x88x48cm  
Hook: Small 24 pcs, Large 2pcs



ITEM NO. MS-DRL03  
Material: Steel  
Size: 50x80x40cm



ITEM NO. MS-ES50 LENGTH: 50mm  
 ITEM NO. MS-ES80 LENGTH: 80mm  
 ITEM NO. MS-ES120 LENGTH: 120mm  
 THREAD: M14/ 5/8"



**Measuring Cup**

ITEM NO. MS-MSC01

Volume: 100ml or 3.2oz

Package including: Measuring cup and Matching straws

2 styles to choice:

1. Cut straws to suitable length according to bottle requirements, 500ml or 1000ml
2. The straw is nested up and down, and the length can be adjusted by yourself, 500ml or 1000ml



**Wheel Cover**

ITEM NO. MS-WHC01

Fits wheels up to 22" in diameter,  
 oxford cloth fabric coated with PU



**Detailing Swabs**

ITEM NO. MS-DS01

- Long-Reach Microfiber Overall Length: 165mm
- Large Square Foam Overall Length: 125mm
- Large Square Microfiber Overall Length: 125mm
- Dual-Head Microfiber Overall Length: 92mm
- Fine-Point Foam Overall Length: 76mm





### Coating Thickness Gauges

ITEM NO. MS-CTG01

Size / Weight / Case material: 114mmX53mmX25mm / 80g / ABS  
 Measuring Range: 0~2000 μm

Measuring Principle: Fe: Magnetic induction NFe: Eddy currents  
 Including:

1. Coating Thickness Gauge packing with a plastic box .
2. USB Cable
3. Calibration materials
4. User manual
5. A CD for APP download

note: need work with two 1.5V AAA batteries  
 (need customer buy by themselves )



### Coating Thickness Gauge

ITEM NO. MS-CTG02

Size: 70.30\*38.6\*149.59 mm / 2.7\*1.5\*5.88 inch Weight: 100 grams  
 Measuring Range: 0~1500 μm / 0~59mil / 0~1.5mm  
 Minimum Thickness Of Metal Substrat: 0.5mm

Packing List:

1. Coating Thickness Gauge with internal F/NF probe
2. Battery charger ( Type A plug socket) and USB charging cable
3. Ferrous substrate
4. Non-ferrous substrate
5. Standard foils (6 pcs)
6. User Manual in English
7. Hard Carrying case

note: need work with two 1.5V AAA batteries  
 (need customer buy by themselves )



### Digital Coating Thickness Gauge

ITEM NO. MS-CTG03

Size: 62x27x121.5mm  
 Measuring Range: 0~1800 μm / 70.8mil / 1.8mm  
 Minimum Thickness Of Metal Substrat: 0.5mm  
 Operating Humidity: 10~95% RH

Competitive paint depth gauge is designed for 0~1800 μm thickness measurement. The paint thickness gauge has zero calibration, two-point calibration and basic calibration. Coating thickness gauge is highly accurate and compact tester, which comes with 0.05mm/2mil resolution car mode and 0.01mm/1mil resolution user modes.

note: need work with two 1.5V AAA batteries  
 (need customer buy by themselves )



## MINI HANDHELD CAR DRYER

ITEM NO.	Power	Volume	Cord Length	Rated Frequency	Horsepower
MS-MHD01	110-240V, 1200W	22000FPM, 90CFM	6m(20ft)	50-60Hz	1.5HP

Included: 2 nozzles available

Mini handheld car dryer may be light and compact, but it has strong impact.

<p><b>THICKENED FILTERED AIR ELEMENT</b></p>	<p><b>FLEXIBLE AND CONVENIENT HANDLE</b></p>	<p><b>6M(20FT)POWER CORD</b></p>	<p><b>2 NOZZLES TO SUIT ANY JOB</b></p>
--	--	----------------------------------	---

- The efficient 1.5HP motor increases air temperature, up to 25 degrees above ambient temperature, which provides faster drying.
- It's filtered air is ideal for delicate surfaces like paint, chrome, and plastics.
- The ergonomic handle optimizes reaching every area in any orientation.
- Perfect for removing water out of all the hard-to-reach places like grilles, bumpers, vents, and wheels.
- More efficient and powerful, while remaining light weight.

Mini Handheld Dryer may be light and compact, but it packs a big punch. Ideal for safely and easily drying every bit of a vehicle, it comes with a handy 20ft/ 6M Cord and a choice of 2 nozzles to suit any job.

### Air Filter

Filter the air and thicken the filter element to avoid sucking some dust particles into the motor.



### Contactless Drying

Stops marring & swirls

20ft / 6m  
Professional Cord



## TWINS MOTOR TOUCHLESS CAR DRYER



Meet the Twins Motor Touchless Car Dryer, the ultimate car dryer boasting twin motors generating 8.5HP power. This powerhouse swiftly blasts water off surfaces, ensuring a quicker, scratch-free dry compared to traditional methods. With over 65,000 FPM at peak power and a variable dial for control, it offers rapid drying while maintaining safety for delicate areas. Its swiveling wheelbase, safe lock system, and an extensive 26ft hose ensure easy maneuverability and comprehensive coverage for cars, bikes, boats, and more. Mount it effortlessly with the customer optional wall bracket, keeping the blower ready for action. Experience the evolution in drying—Twins Motor Touchless Car Dryer delivers power, precision, and convenience for a flawless finish, 80% faster than standard methods.

ITEM NO.	Voltage	Power	Air flow	Power cable length	Hose length	Style
MS-CDB01	110-240V/50-60Hz	2400W	65000FPM	20ft/6m	26ft/8m	General
MS-CDB01 V2	110-240V/50-60Hz	2400W	65000FPM	20ft/6m	26ft/8m	Upgraded with Remote Control

8.5HP via twin motors      Variable Air Speed Control  
**Customized Twin Motor Touchless Car Dryer or V2 with Remote Control can optional**

**Dimensions: 15.55(L) x 11.99(W) x 8.39(H) in    39.5(L) x 30.45(W) x 21.3(H) cm**

## FEATURES



01

Two silencing inner barrels and Powerful Twin Motors  
 Dries engines and components quickly to help prevent corrosion. Reduce noise and fuselage failures built-in double-layer silencer filter cotton, sound insulate debris from entering the body, reduce body failure.



02

Its swiveling wheelbase, safe lock system, and an extensive 26ft hose ensure easy maneuverability and comprehensive coverage for cars, bikes, boats, and more.



03

Mount it effortlessly with the customer optional wall holder (Car dryer wall holder & Hose wall holder), keeping the blower ready for action.



### Car Dryer Wall Mount

ITEM NO. MS-CH10

Package including: 2pcs/set

Dimension and weight:

6.49(L) x 6.16(W) x 0.65(H) in, 0.77lb

16.48(L) x 15.64(W) x 1.65(H) cm, 0.35kg



### Hose Wall Holder for Car Dryer

ITEM NO. MS-CH11

Color: Black Painted Steel

Dimension and weight:

15.91 (L) x 13.74(W) x 2.3 (H) in

40.4 (L) x 34.9(W) x 5.85 (H) cm



## SINGLE MOTOR TOUCHLESS CAR DRYER

Touchless drying prevents scratches and swirls.

Powerful single motors blast water away from surfaces, up to 80 times faster than traditional drying methods.

Forces water from smaller areas such as around side mirror housings, filler caps, wheel spokes, calipers, and nuts.

Dries engines and components quickly to help prevent corrosion.

Single Motor Touchless Car Dryer **with remote control** can be used to remotely adjust the wind speed and turn the machine on/off.



MS-CDS01



MS-CDS01 V2

### Technical Data

ITEM NO.	Power	Air flow	Power cable length	Horsepower	Voltage	Style
MS-CDS01	2000W	45000FPM	6m(20ft)	5m(16ft)	110-240V/50-60Hz	General
MS-CDS01 V2	2000W	45000FPM	6m(20ft)	5m(16ft)	110-240V/50-60Hz	Upgraded with Remote Control

Customized Single Motor Touchless Car Dryer or V2 with Remote Control can optional

#### NOTE:

Hose wall holder optional

Car dryer wall holder optional

**Hose wall holder and dryer wall holder not included**



## JETFORCE NANO CORDLESS DRYER



ITEM NO.	Max Wind Speed	Max Wind Pressure	Batteries Rated	Speed Regulation
MS-NCD01	163mph (73m/s)	3200 Pa	18V-21V	Continuously Variable Transmission

Includes: 5.0Ah Lithium-ion Battery & Charger; Completely Dry Any Car or Truck With 1 Battery Use  
15 Minute Run Time On Fully Charged Battery, with 1pc longer 52mm Orifice nozzle  
80,000 RPM And 163 MPH Of Pure Drying Power EU or US charger

- **Unrestricted Portability:** Cordless design allows you to effortlessly maneuver and clean hard-to-reach areas without being tethered by cords.
- **Exceptional Blowing Power:** Equipped with a high-speed brushless DC motor, this blower makes quick work of drying, dusting, and cleaning tasks.
- **Multi-Purpose Versatility:** An all-in-one solution for home, commercial, and outdoor use, it excels at everything from drying cars to clearing snow.
- **Ergonomic & Durable Design:** The lightweight and durable construction allows for comfortable, single-hand operation and long-lasting reliability.
- **Extended Battery Life:** Powered by rechargeable lithium-ion batteries, you'll enjoy extended run times and consistent power.

The JetForce Nano Cordless Dryer is the ultimate portable cleaning and drying solution! This lightweight, handheld blower boasts a high-speed brushless DC motor, delivering a powerful 163mph airflow and 1200G of thrust for unparalleled performance. Ideal for a wide range of tasks, from drying your car to clearing leaves, its cordless design and long-lasting, rechargeable lithium-ion battery make it perfect for both indoor and outdoor use.





# MULTI-FUNCTIONAL HOLDER

Keep your within reach with a versatile storage organization. Enjoy a –free space and effortless access to your car detailing items. Stay organized and in control with a holder. Access your car detailing accessories whenever you need them, adding a of convenience to your detailing.



### Polisher Holder

ITEM NO. MS-PH01

Size: 20x65x7.5cm

Material: Iron

Single Position



Hold For Small Polisher



### Polisher Holder

ITEM NO. MS-PH05

Size: 16x13x7cm

Single Position



### Polisher Holder

ITEM NO. MS-PH03

Size: 55x30x6.5cm

Material: Iron



### Polisher Holder

ITEM NO. MS-PH04

Size: 55x31x7.5cm

Material: Iron



### Polisher Holder

ITEM NO. MS-PH02

Size: 35x65x7.5cm

Material: Iron

Double Position



Hold For Small Polisher



### Polisher Holder Single Position

ITEM NO. MS-PH06-S

Size: 33x22.5x7.5cm

Material: Iron

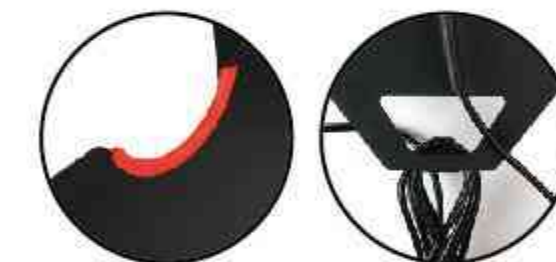

### Polisher Holder Double Position

ITEM NO. MS-PH06-D

Size: 33x40x7.5cm

Material: Iron



# Wheel Stand Pro



## Wheel Stand Pro

ITEM NO. MS-MWS03

Color: Black

Material: Powder Coated Steel

Dimension and Weight:

17.72 x 14.57 x 4.72in, 11.4 lbs

45 x 37 x 12cm, 5.17kg

Shaft Length: 13.5in(34.5cm)

Distance between rollers: 26.85 – 37.15 cm

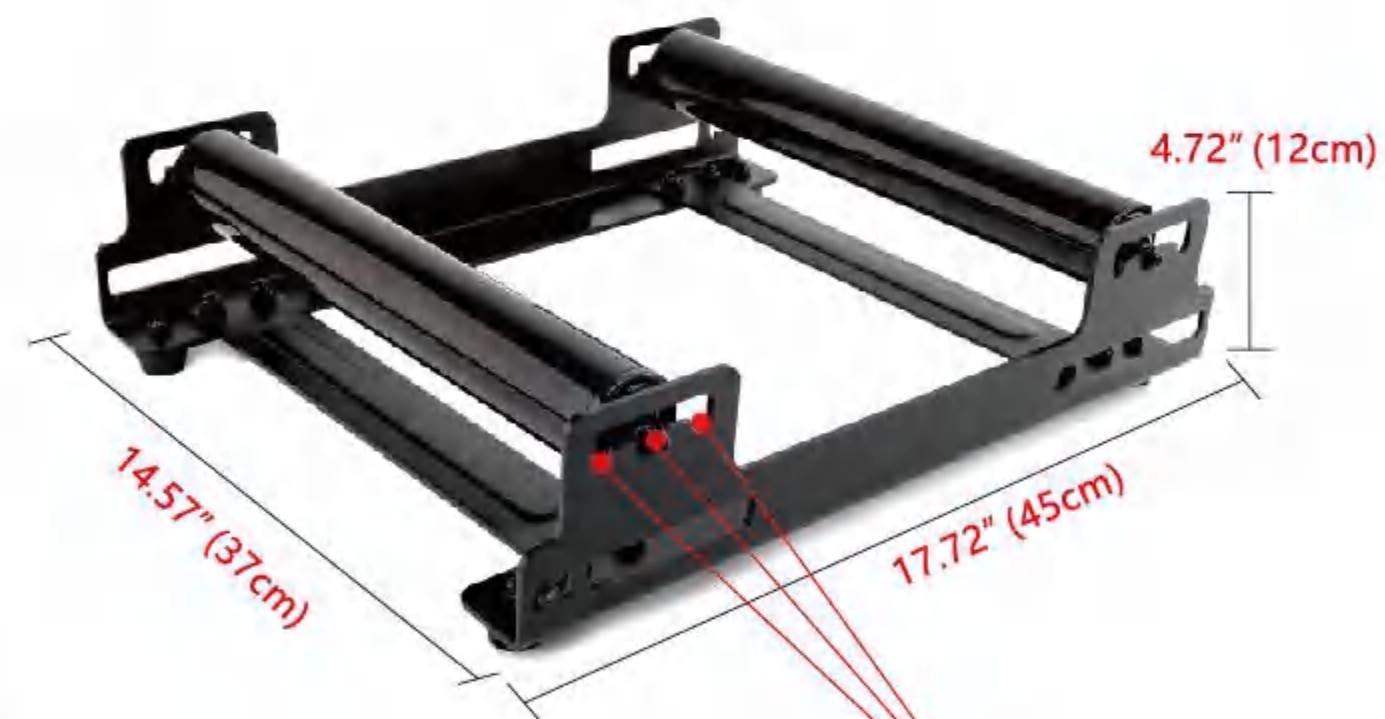

3-setting adjustable for any tire/rim detailing

## Features

- **Universal Fit & 360° Access:** Effortlessly detail any tire and rim size with three adjustable settings and complete 360° rotation, ensuring no spot is missed for a flawless finish
- **Durable & Smooth Rotation:** Enjoy a rust-resistant, powder-coated finish and sealed bearings, allowing for smooth, effortless spinning and long-lasting performance
- **Stable & Protective Base:** Protect your surfaces and prevent slippage with the sturdy rubber base, providing a secure and scratch-free detailing experience
- **Ergonomic Design & Reduced Strain:** Elevate your wheels to a comfortable working height, minimizing bending and reaching, so you can detail with ease and comfort





**Maxshine Wheel Stand**

ITEM NO. MS-MWS01

Length: 58 cm Width from the wall: 34.5 cm  
Height: 91.5 cm



**Maxshine Extra Large Wheel Stand**

ITEM NO. MS-MWS01 XL

Length: 58 cm Width from the wall: 53 cm  
Height: 91.5 cm



**Maxshine Wheel & Tire Detailing Stand**

ITEM NO. MS-MWS01 R

Size: 91.5 X 58 X 34.5 cm  
Weight: 12 kg Style: 3 pcs Red rollers Color: Black+Red



**Wheel Stand With LED Light**

ITEM NO. MS-MWS01-LED

Size: 58(L) x 36.5(W) x 91.5(H)cm  
Color: Black with Red LED



### Multifunctional holder

ITEM NO. MS-MH02  
 Size: 41x6x52cm  
 Material: Iron



### Trigger Sprayer Holder

ITEM NO. MS-MH03  
 Size: 50x5x2cm  
 Material: Iron



### Detailing Brush Holder

ITEM NO. MS-BH01  
 Length: 41cm Width: 5cm  
 Height: 5cm Hole Size: 2.5cm  
 Material: Iron



### Detailing Brush Hanger

ITEM NO. MS-MH05  
 Length: 50cm Width: 4cm Hook mounts: 6 hooks  
 Hook length: 5cm Hook width: 7mm Hook spacing: 9.2cm



### Multifunctional holder

ITEM NO. MS-MH01  
 Size: 50x4.8x5cm  
 Slot size:  $\varnothing$ 9cm  
 Material: Iron



### Snow Foam Lance Organizational Holder

ITEM NO. MS-MH04  
 Length: 13cm Width: 7cm Slot size:  $\varnothing$ 2.5cm



### Foam Cannon Wall Mount

ITEM NO. MS-MH06  
 Size: 38.9x18cm Material: Iron  
 Suitable For: 1/4" plug, 1/4" Quick Connect  
 Connections: 3PCS Copper Connect



### WALL MOUNTED FILM HANGER - PPF AND VINYL 5 ROLL HOLDER

ITEM NO. MS-WFH01  
 Hanger Dimensions: 110(H) x 15(W) cm  
 Steel Tube Dimensions: 164(L) x 2(W) cm  
 Material: Steel



**Foam Cannon Wall Mount & Nozzle Holder**

ITEM NO. MS-MH07  
 Size: 39 (L) x 14(W) x 3.5(H)cm      Weight: 1.16kg  
 Material: High Quality Metal with Paint  
 Included: 2PCS 1/4" Female Quick Connector  
 1PC 1/4" Male Quick Connector



**Spray Bottle Racks-16oz/32oz**

ITEM NO. MS-CH02  
 Length: 540mm  
 Width: 190mm  
 Height: 180mm  
 Slot size: 85mm  
 Material: Iron  
 Useful: 16OZ/ 32OZ Bottle Only

**Spray Bottle Racks-16oz**

ITEM NO. MS-CH02B  
 Length: 464mm  
 Width: 100mm  
 Height: 170mm  
 Slot size: 70mm  
 Material: Iron  
 Useful: 16OZ Bottle Only

**Ceramic Coating Holder**

ITEM NO. MS-CH03  
 Length: 200 mm  
 Width: 55mm  
 Height: 30 + 20 mm  
 Slot size: 42mm  
 Material: Iron



Snow Master Foam Cannon Holder

**Snow Master Foam Cannon Holder**

ITEM NO. MS-CH04  
 Length: 120 mm  
 Width: 120mm  
 Height: 175mm  
 Material: Iron



Foam Cannon Bucket Mount

**Foam Cannon Bucket Mount**

ITEM NO. MS-CH05  
 Length: 60 mm  
 Width: 90.7mm  
 Height: 85.82mm  
 Weight: 0.23kg  
 Material: Iron



Customized design is available

**Compound Holder**

ITEM NO. MS-CH01  
 Length: 460 mm  
 Width: 100mm  
 Height: 80 + 30 mm  
 Slot size: 85mm  
 Material: Iron



**Premium Wall Mount Foam Cannon And Tornador Holder**

ITEM NO. MS-CH09  
 Size: 8.27" Tall x 5.91" Wide x 6.3" Deep  
 Material: Iron  
 Useful:  
 The bottle opening is 5.27" – so any bottle with a diameter less than 5.27" and a sturdy flat base will work.



### Foam Pads Holder

- ITEM NO. MS-FPH-80**  
Suitable for 3" Foam pad  
High: 350mm Dia: 105mm Material: Iron
- ITEM NO. MS-FPH-160**  
Suitable for 5" Foam pad  
High: 350mm Dia: 160mm Material: Iron
- ITEM NO. MS-FPH-180**  
Suitable for 6" Foam pad  
High: 355mm Dia: 180mm Material: Iron



**ITEM NO. MS-MH09**  
Size: 18 x 8.3 x 22cm  
Material: Steel

### Universal Wall Mount Hanger

**ITEM NO. MS-CH06**  
Size: 8 x 2.5cm  
Weight: 0.047kg  
Material: Iron



### Pressure Washer Gun & Snow Foam Lance Wall Mount

**ITEM NO. MS-MH08** Size: 36 x 23 x 4.7cm  
Material: Steel



### Glove Box Holder

**ITEM NO. MS-GBH01**  
Length: 14cm Width: 9cm  
Height: 25cm Material: Iron

- Made of high-quality resistant steel
- Powder coating finish to provide additional protection against oxidation.
- Designed to fit most sized boxes of gloves.
- Keep your gloves right where you need them.
- Easy wall mounting installation



### High Pressure Spray Gun Holder

**ITEM NO. MS-CH07**  
Size: 80x150x50.5mm Thickness: 20mm  
Weight: 0.3kg Material: Iron

- Compatible with Maxshine High Pressure Water Gun.
- Easy installation, uses only 2 screws.
- Made of high-quality steel materials.
- Not Included: High Pressure Spray Gun.



### Phone & Headphone Holder

**ITEM NO. MS-CH08**  
Size: 120.9x 88.5x 217.3cm Weight: 0.3kg  
Withstand Weight: 3.3lbs Material: Iron

- Mounts to Wall w/ Screws Provided.
- Holds Most Phone Models and Headphone Sizes.
- High Quality Steel Construction.
- Withstand Weight of 3.3 lbs.



**Stainless steel car Mat Hanger-Single**

ITEM NO. MS-MCH01  
 Size: 11.81x1.93x2.52 in (30x4.9x6.4 cm)  
 Weight: 0.42 kg  
 Material: Stainless Steel



**Iron Bucket Dolly**

ITEM NO. MS-BD02  
 Quality Special Paint Processing ,  
 No Rust,40x40cm with wheels,  
 2 holes for shampoo, 5 holes for brushes



**Buckets Dolly**

ITEM NO. MS-BD01  
 Material: Heavy duty molded plastic,  
 Holds 3.5 to 7 gallon buckets